



SmartGen
ideas for power

HGM9510

GENSET PARALLEL (WITH GENSET) UNIT

USER MANUAL



SMARTGEN (ZHENGZHOU) TECHNOLOGY CO.,LTD.



Chinese trademark

SmartGen English trademark

SmartGen — make your generator *smart*

SmartGen Technology Co., Ltd.

No. 28 Jinsuo Road

Zhengzhou city

Henan Province

P. R. China

Tel: +86-371-67988888/67981888

+86-371-67991553/67992951

+86-371-67981000(overseas)

Fax: 0086-371-67992952

Web: <http://www.smartgen.com.cn>

<http://www.smartgen.cn>

Email: sales@smartgen.cn

All rights reserved. No part of this publication may be reproduced in any material form (including photocopying or storing in any medium by electronic means or other) without the written permission of the copyright holder.

SmartGen Technology reserves the right to change the contents of this document without prior notice.

Version history

Date	Version	Contents
2013-02-18	1.0	Original release
2013-08-06	1.1	Modify the outside drawing and the main display description; Modify some parameters' default value; Add the description of "Power Management Mode" and "Load Shedding Control"
2016-11-03	1.2	1. Add timer setting of gas gen-set. 2. Add functions of input ports and output ports.

CONTENTS

1	OVERVIEW	5
2	MODULES COMPARISON	6
3	PERFORMANCE AND CHARACTERISTICS	6
4	SPECIFICATION	9
5	OPERATION	10
5.1	INDICATOR LIGHT	10
5.2	PUSHBUTTONS.....	11
5.3	LCD DISPLAY	12
5.3.1	MAIN DISPLAY	12
5.3.2	USER MENU AND PARAMETERS SETTING MENU.....	14
5.4	AUTO START/STOP OPERATION	17
5.5	MANUAL START/STOP OPERATION	18
5.6	SWITCH CONTROL PROCEDURES	18
5.6.1	MANUAL TRANSFER PROCEDURES	18
5.6.2	AUTOMATIC CONTROL PROCEDURE	19
6	PROTECTIONS	20
6.1	WARNING ALARMS	20
6.2	SHUTDOWN ALARMS	22
6.3	TRIP AND STOP ALARMS	24
6.4	TRIP ALARM.....	25
7	WIRING CONNECTION	26
8	SCOPES AND DEFINITIONS OF PROGRAMMABLE PARAMETERS	28
8.1	CONTENTS AND SCOPES OF PARAMETERS	28
8.2	ENABLE DEFINITION OF PROGRAMMABLE OUTPUT PORTS.....	39
8.2.1	DEFINED PERIOD OUTPUT	43
8.2.2	DEFINED COMBINATION OUTPUT	44
8.3	DEFINED CONTENTS OF PROGRAMMABLE INPUT PORTS (ALL ACTIVE WHEN CONNECT TO GRAND (B~)).....	45
8.4	SELECTION OF SENSORS	47
8.5	CONDITIONS OF CRANK DINSCONNECT SELECTION	48
9	PARAMETERS SETTING	48
10	SENSORS SETTING	49
11	COMMISSIONING	49
11.1	STEP 1. SINGLE UNIT DEBUGGING.....	49
11.2	STEP 2: MANUAL PARALLEL OPERATION OFF-LOAD.....	49
11.3	STEP 3: MANUAL PARALLEL OPERATION ON-LOAD	49
11.4	STEP 4: AUTOMATIC PARALLEL OPERATION.....	51
12	TYPICAL APPLICATION	51
13	POWER MANAGEMENT MODE	53
14	LOAD SHEDDING	54
15	INSTALLATION	55
16	CONNECTIONS OF CONTROLLER WITH J1939 ENGINE	56



16.1	CUMMINS ISB/ISBE	56
16.2	CUMMINS QSL9.....	56
16.3	CUMMINS QSM11 (IMPORT)	57
16.4	CUMMINS QSX15-CM570	57
16.5	CUMMINS GCS-MODBUS	57
16.6	CUMMINS QSM11	58
16.7	CUMMINS QSZ13.....	58
16.8	DETROIT DIESEL DDEC III / IV.....	58
16.9	DEUTZ EMR2	59
16.10	JOHN DEERE	59
16.11	MTU MDEC.....	59
16.12	MTU ADEC(SMART MODULE)	60
16.13	MTU ADEC(SAM MODULE).....	60
16.14	PERKINS	60
16.15	SCANIA.....	61
16.16	VOLVO EDC3	61
16.17	VOLVO EDC4	61
16.18	VOLVO-EMS2.....	62
16.19	YUCHAI	62
16.20	WEICHAI.....	62
17	USB.....	63
18	FAULT FINDING	64



1 OVERVIEW

HGM9510 controller is designed for manual/auto parallel system generators with similar or different capacity. Additionally, it is suitable for single unit constant power output and mains paralleling. It allows automatic start/stop, parallel running, data measurement, alarm protection as well as remote control, remote measurement and remote communication function. It fits with LCD display, optional Chinese, English and other languages interface, and it is reliable and easy to use.

Utilizing the GOV (Engine Speed Governor) and AVR (Automatic Voltage Regulator) control function, the controller is able to synchronize and share load automatically; it can be used to parallel with other HGM9510 controller.

HGM9510 controller also monitors the engine, indicating the operational status and fault conditions accurately. When abnormal condition occurs, it splits bus and shuts down the genset, simultaneously the exact failure mode information is indicated by the LCD display on the front panel. SAE J1939 interface enables the controller to communicate with various ECU (ENGINE CONTROL UNIT) which fitted with J1939 interface.

The powerful 32-bit Microprocessor contained within the module allows for precision parameters measuring, fixed value adjustment, time setting and set value adjusting and etc.. Majority parameters can be configured from front panel, and all parameters can be configured by USB interface (or RS485) to adjust via PC. It can be widely used in all types of automatic gen-set control system with compact structure, advanced circuits, simple connections and high reliability.

2 MODULES COMPARISON

		HGM 9210	HGM 9220	HGM 9310	HGM 9320	HGM 9410	HGM 9420	HGM 9610	HGM 9620	HGM 9510	HGM 9520
LCD	Dimension	3.7"						4.3"			
	pixel	132 x 64						480 x 272			
AMF			•		•		•		•		•
BUS Monitoring										•	
Parallel connection										•	•
Expansion module								•	•		
Input Port		7	7	7	7	7	7	8	8	7	7
Output Port		8	8	8	8	8	8	8	8	8	8
Sensor Number		5	5	5	5	5	5	5	5	5	5
Neutral (Earth) current								•	•		
Schedule function		•	•	•	•	•	•	•	•	•	•
ETHERNET								•	•		
RS485				•	•	•	•	•	•	•	•
GSM				•	•	•	•	•	•		
J1939						•	•	•	•	•	•
USB		•	•	•	•	•	•	•	•	•	•
LINK		•	•								
Real-time clock		•	•	•	•	•	•	•	•	•	•
Event log		•	•	•	•	•	•	•	•	•	•
Micro SD card								•	•		

▲ NOTE:

- (1) Two of the outputs are fixed: start output and fuel output.
- (2) HGM9510's analog sensors are composed by 3 fixed sensors (temperature, pressure, level) and 2 configurable sensors.

▲ NOTE:

The features of HGM9210/HGM9220/HGM9310/HGM9320/HGM9410/HGM9420/HGM9520/HGM9610/HGM9620 controllers mentioned in this document may change, please check the corresponding user manual for accurate information.

3 PERFORMANCE AND CHARACTERISTICS

- With ARM-based 32-bit SCM, high integration of hardware and more reliable;
- 480x272 LCD with backlight, multilingual interface (including English, Chinese or other languages) which can be chosen at the site, making commissioning convenient for factory personnel;
- Improved LCD wear-resistance and scratch resistance due to hard screen acrylic;
- Silicon panel and pushbuttons for better operation in high/low temperature environment;
- RS485 communication port enable remote control, remote measuring, remote communication via ModBus protocol.
- Fitted with CANBUS port and can communicate with J1939 genset. Not only can you monitoring frequently-used data (such as water temperature, oil pressure, engine speed, fuel consumption and so on) of ECU machine, but also control start, stop, raising speed and speed droop via CANBUS port.
- Suitable for 3-phase 4-wire, 3-phase 3-wire, single phase 2-wire, and 2-phase 3-wire systems with voltage 120/240V and frequency 50/60Hz;
- Collects and shows 3-phase voltage, current, power parameter and frequency of Bus/mains.
- For Bus, controller has loss of phase and phase sequence wrong detection functions; For generator, controller has over voltage, under voltage, over frequency, under frequency, over current, over power, reverse power, loss of phase, phase sequence wrong detection functions;
- Synchronization parameters : Voltage Difference Between Bus and Mains, Frequency Difference Between Bus and Mains, Phase Difference Between Bus and mains;
- Multiple running modes in auto state: with load running, off load running, demand parallel running;
- Ramp on and ramp off function;
- 3 fixed sensors (temperature, oil pressure and liquid level);
- 2 configurable sensors can be set as sensor of temperature, oil pressure or fuel level;
- More kinds of curves of temperature, oil pressure, fuel level can be used directly and users can define the sensor curves by themselves ;
- Precision measure and display parameters about Engine,

Temp. (WT)	°C/°F (unit) both be displayed
Oil pressure (OP)	kPa/psi/bar(unit) all be displayed
Fuel level (FL)	%(unit)
Speed (SPD)	r/min(unit)
Battery Voltage (VB)	V (unit)
Charger Voltage (VD)	V (unit)

Hour count (HC) can accumulate Max. 65535 hours.

Start times can accumulate Max. 65535 times

- Protection: automatic start/stop of the gen-set, ATS(Auto Transfer Switch) control with perfect fault indication and protection function;
- All output ports are relay output;
- Parameter setting: parameters can be modified and stored in internal EEPROM memory and cannot be lost even in case of power outage; most of them can be adjusted using front panel of the controller and all of them can be modified using PC via USB or RS485 ports;
- Multiple crank disconnect conditions (speed sensor, oil pressure, generator frequency) are optional;
- Widely power supply range DC(8~35)V, suitable to different starting battery voltage environment;
- Event log, real-time clock, scheduled start & stop generator (can be set as start genset once a day/week/month whether with load or not);
- Accumulative total run time and total electric energy of A and B. Users can reset it as 0 and re-accumulative the value which make convenience to users to count the total value as their wish.
- Can control engine heater, cooler and fuel pump.
- With maintenance function. Actions (warning, trip and stop, shutdown) can be set when maintenance time out;
- All parameters used digital adjustment, instead of conventional analog modulation with normal potentiometer, more reliability and stability;
- IP55 waterproofness level can be achieved with the help of rubber-ring gasket between shell and control panel.
- Metal fixing clips enable perfect in high temperature environment ;
- Modular design, self-extinguishing ABS plastic shell, pluggable terminal, built-in mounting , compact structure with easy installation ;

4 SPECIFICATION

Parameter	Details
Working Voltage	DC8. 0V to 35. 0V, uninterruptible power supply
Overall Consumption	<4W (Standby mode: ≤2W)
AC Input:	
3 Phase 4 Wire	AC 15V - 360V (ph-N)
3 Phase 3 Wire	AC 30V - 620V (ph- ph)
Single Phase 2 Wire	AC 15V - 360V (ph-N)
2 Phase 3 Wire	AC 15V - 360V (ph-N)
Alternator Frequency	50Hz/60Hz
Speed Sensor Voltage	1. 0 V to 24 V (RMS)
Speed Sensor Frequency	Maximum 10,000 Hz
Start Relay Output	16A DC28V power supply output
Fuel Relay Output	16A DC28V power supply output
Flexible Relay Output 1	7A DC28V power supply output
Flexible Relay Output 2	7A DC28V power supply output
Flexible Relay Output 3	7A DC28V power supply output
Flexible Relay Output 4	7A 250VAC passive output
Flexible Relay Output 5	7A 250VAC passive output
Flexible Relay Output 6	7A 250VAC passive output
Case Dimensions	266mm x 182mm x 45mm
Panel Cutout	214mm x 160mm
CT Secondary Current	Rated 5A
Working Conditions	Temperature: (-25~+70)°C Humidity: (20~93)%RH
Storage Conditions	Temperature:(-30~+80)°C
Protection Level	IP55 Gasket
Insulation Intensity	Apply AC2.2kV voltage between high voltage terminal and low voltage terminal; The leakage current is not more than 3mA within 1min.
Weight	0.95kg

5 OPERATION

5.1 INDICATOR LIGHT

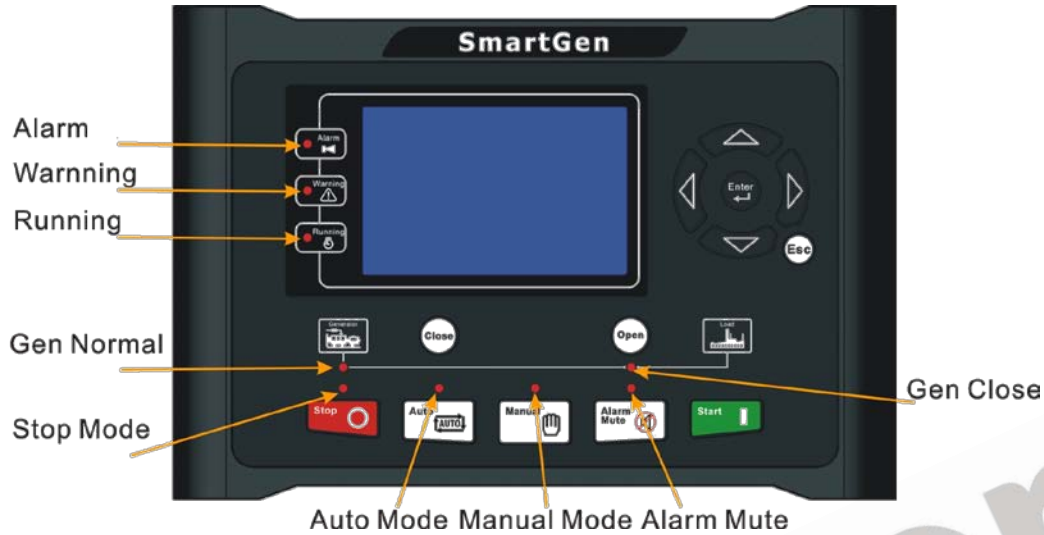

NOTE: Selected light indicators description:

Warning indicator and Alarm indicator:



Alarm Type	Warning Indicator	Alarm Indicator
Warning	Slow flashing	Slow flashing
Trip Alarm	Slow flashing	Slow flashing
Shutdown Alarm	Off	Fast flashing
Trip and Stop Alarm	Off	Fast flashing

Running indicator: illuminated from crank disconnect to ETS while off during other periods.

Generator normal light: It is light on when generator is normal; flashing when generator state is abnormal; off when there is no generator power.

5.2 PUSHBUTTONS

Icon	Button	Description
	Stop	Stop running generator in Auto/Manual mode; Lamp test (press at least 3 seconds); Reset alarm in stop mode; During stopping process, press this button again to stop generator immediately.
	Start	Start genset in Manual mode.
	Manual Mode	Press this key and controller enters in Manual mode.
	Auto Mode	Press this key and controller enters in Auto mode.
	Mute/Reset Alarm	Alarming sound off; If trip alarm occurs, pressing the button at least 3 seconds can reset this alarm.
	Close	Close breaker in manual mode.
	Open	Open breaker in manual mode.
	Up/Increase	1) Screen scroll; 2) Up cursor and increase value in setting menu.
	Down/Decrease	1) Screen scroll; 2) Down cursor and decrease value in setting menu.
	Left	1) Screen scroll; 2) Left move cursor in setting menu.
	Right	1) Screen scroll; 2) Right move cursor in setting menu.
	Set/Confirm	Select viewing area.
	Exit	1) Return to main menu; 2) Return to previous menu in setting menu.





NOTE: Press  and  simultaneously in manual mode will force generator to crank. Successful start will not be judged according to crank disconnect conditions, operator will have to crank the starter motor manually; when operator decides that the engine has fired, he/she should release the button and start output will be deactivated, safety on delay will be initiated.



WARNING: Default password is 00318, user can change it in case of others change the advanced parameters setting. Please clearly remember the password after changing. If you forget it, please contact SmartGen services and send all information in the controller page of “**ABOUT**” to us.

5.3 LCD DISPLAY

5.3.1 MAIN DISPLAY

Main screen show pages; use   to scroll the pages and   to scroll the screen.

★**Main Screen**, including as below,

Gen: voltage, frequency, current, active power, reactive power

Bus: voltage, frequency

Engine: speed, temperature, oil pressure

Some status

★**Status**, including as below,

Status of genset and ATS

★**Engine**, including as below,

Engine speed, engine temperature, engine oil pressure, fuel level, flexible sensor 1, flexible sensor 2, battery voltage, charger voltage, engine accumulated run, accumulated start times.

▲**NOTE:** If connected with J1939 engine via CANBUS port, this page also includes: coolant pressure, coolant level, fuel temperature, fuel pressure, inlet temperature, exhaust temperature, turbo pressure, total fuel consumption and so on. (Different engine with different parameters)

★**Generator**, including as below,

Phase voltage, line voltage, frequency, phase sequence, current, Active Power(positive and negative), total active power (positive and negative), Reactive Power(positive and negative), total reactive power (positive and negative), Apparent Power, total apparent power, Power Factor(positive and negative), average power factor (positive and negative), accumulated energy (kWh, kVarh, kVAh), multi power, earth current, negative sequence current.

▲**NOTE:** Power factor shows as following,

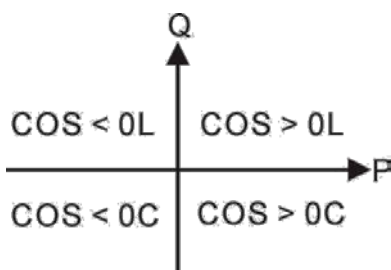

Remark:

P stands for active power

Q stands for inactive power

Power factor	Conditions	Active power	Reactive power	Remark
COS>0L	P>0,Q>0	Input	Input	Load is inductive resistance.
COS>0C	P>0,Q<0	Input	Output	Load is capacitance resistance.
COS<0L	P<0,Q>0	Output	Input	Load is equal to one under excitation generator.
COS<0C	P<0,Q<0	Output	Output	Load is equal to one over excitation generator.

▲Note:

1. Input active power, generator send active power to load.
2. Output active power, load supply electricity to generator.
3. Input reactive power, generator send reactive power to load.
4. Output reactive power, load send reactive power to generator.

★**Bus**, including as below,

Phase voltage, line voltage, frequency, phase sequence

★**SNYC**, including as below,

Volt difference, freq difference, angle difference, active power percentage, target active power percentage, reactive power percentage, target reactive power percentage, GOV percentage, AVR percentage and MSC status

★**Alarm:**

▲**NOTE:** For ECU alarms and shutdown alarms, if the alarm information is displayed, check engine according to it, otherwise, please check the generator manual according to SPN alarm code.

★**Event log**

Make records about all start/stop events (shutdown alarm, trip and stop alarm, manual /auto start or stop) and the real time when alarm occurs.

★**Others**, including,

Time and Date, maintenance due, input/output ports status.

★**About**, including,

Issue time of software and hardware version, product PD number.

5.3.2 USER MENU AND PARAMETERS SETTING MENU

Press  key for more than 3s to enter into user manual.

- Parameter

After entering the correct password (factory default password is 00318) you can enter parameter settings screen.

- Language

Selectable Chinese, English and others (default: Espanol)

- Commissioning





On load, off load or custom commissioning can be chosen. Custom commissioning can configure on load or not during commissioning, when to commissioning and select the mode after commissioning (manual mode, auto mode and stop mode).

- Clear users' accumulation

Can clear total run time A and B, total electric energy A and B.

Parameter setting including as following,







- Timer settings
- Engine settings
- Generator settings
- Load settings
- Breaker settings
- Analog sensor settings
- Input port settings
- output port settings
- Module settings
- Scheduling and maintenance settings
- Synchronization settings
- Extension module settings





Return	>Start Delay	Interface 1: Use   to scroll settings,  to enter settings (interface 2),  to exit settings menu.
Timers >	>Return Delay	
Engine	>Preheat Delay	
Generator	>Cranking Time	
Load	>Crank Rest Time	
Breaker	>Safety On Time	
Temp. Sensor	>Start Idle Time	
OP Sensor	>Warming Up Time	
Level Sensor	>Cooling Time	
Config Sensor 1	>Stop Idle Time	
Config Sensor 2	>ETS Hold Time	

Return	> Start Delay	Interface 2: Use to scroll settings, to enter settings (Interface 4), to return to previous menu. (interface 1)
Timers >	> Return Delay	
Engine	> Preheat Delay	
Generator	> Cranking Time	
Load	> Crank Rest Time	
Breaker	> Safety On Time	
Temp. Sensor	> Start Idle Time	
OP Sensor	> Warming Up Time	
Level Sensor	> Cooling Time	
Config Sensor 1	> Stop Idle Time	
Config Sensor 2	> ETS Hold Time	

Return	> Start Delay	Interface 3: Use to scroll settings, to enter settings (Interface 4), to return to previous menu. (Interface 1)
Timers >	> Return Delay	
Engine	> Preheat Delay	
Generator	> Cranking Time	
Load	> Crank Rest Time	
Breaker	> Safety On Time	
Temp. Sensor	> Start Idle Time	
OP Sensor	> Warming Up Time	
Level Sensor	> Cooling Time	
Config Sensor 1	> Stop Idle Time	
Config Sensor 2	> ETS Hold Time	

> Start Delay	00008	Interface 4: Press to enter settings (Interface 5), to return to previous menu. (Interface 6).
> Return Delay		
> Preheat Delay		
> Cranking Time		
>Crank Rest Time		
> Safety On Time		
> Start Idle Time		
> Warming Up Time		
> Cooling Time		
> Stop Idle Time		
> ETS Hold Time		

<ul style="list-style-type: none"> > Start Delay > Return Delay > Preheat Delay 	00008	<p>Interface 5: Press   to change cursor position,   are used for changing cursor value,  Confirm setting (Interface 4),  exit setting (Interface 4).</p>
<ul style="list-style-type: none"> > Cranking Time > Crank Rest Time > Safety On Time > Start Idle Time > Warming Up Time > Cooling Time > Stop Idle Time > ETS Hold Time 		

<ul style="list-style-type: none"> > Start Delay > Return Delay > Preheat Delay 	00008	<p>Interface 6:   are used for changing the setting contents.  Confirm setting (Interface 4),  to return to previous menu. (Interface 1).</p>
<ul style="list-style-type: none"> > Cranking Time > Crank Rest Time > Safety On Time > Start Idle Time > Warming Up Time > Cooling Time > Stop Idle Time > ETS Hold Time > Wait For Stop 		

NOTE: Pressing  can exit setting directly during setting.

5.4 AUTO START/STOP OPERATION

Auto mode is selected by pressing the  button; a LED besides the button will illuminate to confirm the operation.

Automatic Start Sequence:



- 1) When “Remote Start” is active, “Start Delay” timer is initiated;
- 2) “Start Delay” countdown will be displayed on LCD;
- 3) When start delay is over, preheat relay energizes (if configured), “preheat delay XX s” information will be displayed on LCD;
- 4) After the above delay, the Fuel Relay (if configured) is energized, and then one second later, the Start Relay is engaged. The engine is cranked for a pre-set time. If the engine fails to fire during this cranking attempt then the fuel relay and start relay are disengaged for the pre-set rest period; “crank rest time” begins and wait for the next crank attempt.
- 5) Should this start sequence continue beyond the set number of attempts, the start sequence will be terminated, the first line of LCD display will be highlighted with black and Fail to Start fault will be displayed.
- 6) In case of successful crank attempt, the “Safety On” timer is activated, allowing Low Oil Pressure, High Temperature, Under speed and Charge Alternator Failure inputs to stabilise without triggering the fault. As soon as this delay is over, “start idle” delay is initiated (if configured).
- 7) During “start idle” delay, under speed, under frequency, under voltage alarms are inhibited. When this delay is over, “warming up” delay is initiated (if configured).
- 8) In the case of a single generator system, after the “warming up” delay, if generator status is normal, its indicator will be illuminated. If generator voltage and frequency have reached on-load requirements, then the generator close relay will be energized; genset will take load; generator power indicator will illuminate and generator will enter into Normal Running status. If voltage or frequency is abnormal, the controller will initiate shutdown alarm (alarm information will be displayed on LCD).
- 9) In case of running in parallel, after the warming up delay:
 - a) If bus has no voltage, then the controller will send a closing signal to other waiting parallel gensets and generator close relay will activate, this prevents other sets in the system from attempting to close their own breakers at the same time.
 - b) If bus has voltage or other gensets are already closed, the controller will adjust speed and voltage through GOV and AVR to synchronize the gensets to the bus; when synchronism requirements has been achieved, breaker close signal will be initiated and the genset will be paralleled with the bus. Once they are paralleled, the controller will control the generator to gradually accelerate and share load with other paralleled gensets.

▲ **Note:** When started via “Remote Start (off Load)” input, same procedures as above but generator close relay deactivated, moreover, genset off load. When started via “Remote Start (Demand)” input, the genset will start, synchronization, parallel and load sharing automatically according to the pre-set priority order.

Automatic Stop Sequence,

- 1) When the “Remote Start” signal is removed, the Stop Delay is initiated.
- 2) Once this “stop delay” has expired, the module will ramp the load from the generator to remaining set. The Generator Breaker will open and the “Cooling Delay” is then initiated. Should the Remote Start signal be re-activated during the cooling down period, the set will return parallel status. Once the “Cooling Delay” expires, the “Stop Idle” delay is initiated.
- 3) During “Stop Idle” Delay (if configured), idle relay is energized.
- 4) “ETS Solenoid Hold” begins, ETS relay is energized while fuel relay is de-energized, complete stop is detected automatically.
- 5) “Fail to Stop Delay” begins, complete stop is detected automatically.
- 6) When generator is stop completely, “After stop” delay will be initiated. Otherwise, fail to stop alarm is initiated and the corresponding alarm information is displayed on LCD. (If generator is stop successfully after “fail to stop” alarm has initiated, “After stop” delay will be initiated and the alarm will be removed)
- 7) Generator is placed into its standby mode after its “After stop” delay.

5.5 MANUAL START/STOP OPERATION

- 1) Manual mode is selected by pressing the  button; a LED besides the button will illuminate to confirm the operation; then press  button to start the gen-set; can detect crank disconnect condition and generator accelerates to high-speed running automatically. With high temperature, low oil pressure, over speed and abnormal voltage during generator running, controller can protect genset to stop quickly (please refer to No.3~9 of **Automatic Start Sequence** for detail procedures).
- 2) **MANUAL STOP:** Press  can shuts down the running generators. (Please refer to No.2~7 of **Automatic Start Sequence** for detail procedures).

▲ **NOTE:** In “manual mode”, the procedures of ATS please refer to *Switch Control Procedure* of generator in this manual.

5.6 SWITCH CONTROL PROCEDURES

5.6.1 MANUAL TRANSFER PROCEDURES

When controller is in **Manual** mode, the switch control procedures will start through manual transfer procedures. Users can control the loading transfer of ATS via pressing button to switch on or off.

Closing Operation: During genset normal running, press  if generator voltage and frequency have reached on-load requirements

- 1) In case of single unit running, generator closing relay outputs;
- 2) In case of running in parallel:
 - a) If bus has no voltage, then the controller will send a closing signal to other waiting parallel gensets and generator close relay will activate, this prevents other sets in the system from attempting to close their own breakers at the same time.
 - b) If bus has voltage or other gensets are already closed, the controller will adjust speed and voltage through GOV and AVR to synchronize the gensets to the bus; when synchronism requirements has been achieved, breaker close signal will be initiated and the genset will be paralleled to the bus. Once they are paralleled, the controller will control the generator to gradually accelerate and share load with other paralleled gensets.

Opening operation: Press ,

- 1) In case of single unit running, the controller sends open breaker signal.
- 2) During parallel operation, if  button is pressed, first of all, the controller will transfer load to other generators, and only then send an opening signal.

5.6.2 AUTOMATIC CONTROL PROCEDURE

When controller is in auto mode, the switch control procedure is automatic control procedure.

 **Note:** The auxiliary close input should be configured necessarily and make sure the connection is correct.

6 PROTECTIONS

6.1 WARNING ALARMS

Warnings are not shutdown alarms and do not affect the operation of the gen-set. Warning alarms does not lead to shutdown. Warning alarms types are as follows:

No	Type	Description
1	Over Speed	When the controller detects that the engine speed has exceeded the pre-set value, it will initiate a warning alarm.
2	Under Speed	When the controller detects that the engine speed has fallen below the pre-set value, it will initiate a warning alarm.
3	Loss of Speed Signal	When the controller detects that the engine speed is 0 and the action select "Warn", it will initiate a warning alarm.
4	Gen Over Frequency	When the controller detects that the genset frequency has exceeded the pre-set value, it will initiate a warning alarm.
5	Gen Under Frequency	When the controller detects that the genset frequency has fallen below the pre-set value, it will initiate a warning alarm.
6	Gen Over Voltage	When the controller detects that the generator voltage has exceeded the pre-set value, the controller will initiate a warning alarm.
7	Genset Under Voltage	When the controller detects that the genset voltage has fallen below the pre-set value, it will initiate a warning alarm.
8	Gen Over Current	When the controller detects that the genset current has exceeded the pre-set value and the action select "Warn", it will initiate a warning alarm.
9	Fail To Stop	After "fail to stop" delay, if gen-set does not stop completely, it will initiate a warning alarm.
10	Charge Alternator Failure	When the controller detects that charger voltage has fallen below the pre-set value, it will initiate a warning alarm.
11	Battery Under Volt	When the controller detects that start battery voltage has fallen below the pre-set value, it will initiate a warning alarm.
12	Battery Over Volt	When the controller detects that start battery voltage has exceeded the pre-set value, it will initiate a warning alarm.
13	Maintenance Due	When count down time is 0 and the action select "Warn", it will initiate a warning alarm.
14	Reverse Power	If reverse power detection is enabled, when the controller detects that the reverse power value (power is negative) has fallen below the pre-set value and the action select "Warn", it will initiate a warning alarm.
15	Over Power	If over power detection is enabled, when the controller detects that the over power value (power is positive) has exceeded the pre-set value and the action select "Warn", it will initiate a warning alarm.
16	ECU Warn	If an error message is received from ECU via J1939, it will initiate a warning alarm.
17	Gen Loss of Phase	If loss of phase detection is enabled, When controller detects the generator loss phase, it will initiate a warning alarm.
18	Gen Phase Sequence Wrong	When the controller detects a phase rotation error, it will initiate a warning alarm.
19	Switch Fail Warn	When the controller detects that the breaker close or open failure occurs, and the action select "Warn", it will initiate a warning alarm.



No	Type	Description
20	Temperature Sensor Open Circuit	When the controller detects that the temperature sensor is open circuit and the action select "Warn", it will initiate a warning alarm.
21	High Temperature	When the controller detects that engine temperature has exceeded the pre-set value, it will initiate a warning alarm.
22	Low Temperature	When the controller detects that engine temperature has fallen below the pre-set value, it will initiate a warning alarm.
23	Oil Pressure Open Circuit	When the controller detects that the oil pressure sensor is open circuit and the action select "Warn", it will initiate a warning alarm.
24	Low Oil Pressure	When the controller detects that the oil pressure has fallen below the pre-set value, it will initiate a warning alarm.
25	Level Sensor Open Circuit	When the controller detects that the level sensor is open circuit and the action select "Warn", it will initiate a warning alarm.
26	Low Fuel Level	When the controller detects that the fuel level has fallen below the pre-set value, it will initiate a warning alarm.
27	Flexible Sensor 1 Open Circuit	When the controller detects that the flexible sensor 1 is open circuit and the action select "Warn", it will initiate a warning alarm.
28	Flexible Sensor 1 High	When the controller detects that the sensor 1 value has exceeded the pre-set value, it will initiate a warning alarm.
29	Flexible Sensor 1 Low	When the controller detects that the sensor 1 value has fallen below the pre-set value, it will initiate a warning alarm.
30	Flexible Sensor 2 Open Circuit	When the controller detects that the flexible sensor 2 is open circuit and the action select "Warn", it will initiate a warning alarm.
31	Flexible Sensor 2 High	When the controller detects that the sensor 2 value has exceeded the pre-set value, it will initiate a warning alarm.
32	Flexible Sensor 2 Low	When the controller detects that the sensor 2 value has fallen below the pre-set value, it will initiate a warning alarm.
33	Digital Input	When digit input port is set as warning and the alarm is active, it will initiate a warning alarm.
34	Earth Fault	If earth fault detection is enabled, when the controller detects that the earth fault current has exceeded the pre-set value and the action select "Warn", it will initiate a warning alarm.
35	Negative Sequence Current	When the controller detects the imbalance current has exceeded the pre-set value and the action select "Warn" it will initiate a warning alarm.
36	Fail to sync	When the controller does not detect synchronization signal within the pre-set synchronization time, it will initiate a warning alarm.
37	MSC Too Few Sets	When the controller detects fewer modules on the MSC link than the minimum number configured in the unit, it will initiate a warning alarm. There are 2 possible reasons: a) Communication line between the controllers disconnects, which interrupts communication. b) Other parallel gen-sets controllers have not been powered on.
38	Loss of Excitation	When the controller detects that the genset negative reactive power has exceeded the pre-set value, it will initiate a warning alarm.

6.2 SHUTDOWN ALARMS

When controller detects shutdown alarm, it will send signal to open breaker and shuts down generator.

Shutdown alarms as following:

No	Type	Description
1	Emergency Stop	When the controller detects an emergency stop alarm signal, it will initiate a shutdown alarm.
2	Over Speed	When the controller detects that the generator speed has exceeded the pre-set value, it will initiate a shutdown alarm.
3	Under Speed	When the controller detects that the generator speed has fallen below the pre-set value, it will initiate a shutdown alarm.
4	Loss of Speed Signal	When the controller detects that the engine speed is 0 and the action select "Shutdown", it will initiate a shutdown alarm.
5	Gen Over Frequency	When the controller detects that the genset frequency has exceeded the pre-set value, it will initiate a shutdown alarm.
6	Gen Under Frequency	When the controller detects that the genset frequency has fallen below the pre-set value, it will initiate a shutdown alarm.
7	Gen Over Voltage	When the controller detects that the generator voltage has exceeded the pre-set value, the controller will initiate a shutdown alarm.
8	Genset Under Voltage	When the controller detects that the genset voltage has fallen below the pre-set value, it will initiate a shutdown alarm.
9	Fail To Stop	If the engine does not fire after the pre-set number of attempts, it will initiate a shutdown alarm.
10	Gen Over Current	When the controller detects that the genset current has exceeded the pre-set value and the action select "Shutdown", it will initiate a shutdown alarm.
11	Maintenance Due	When count down time is 0 and the action select "Shutdown", it will initiate a shutdown alarm.
12	ECU Shutdown	If an error message is received from ECU via J1939, it will initiate a shutdown alarm.
13	ECU Fail	If the module does not detect the ECU data, it will initiate a shutdown alarm.
14	Reverse Power	If reverse power detection is enabled, when the controller detects that the reverse power value (power is negative) has fallen below the pre-set value and the action select "Shutdown", it will initiate a shutdown alarm.
15	Over Power	If over power detection is enabled, when the controller detects that the over power value (power is positive) has exceeded the pre-set value and the action select "Shutdown", it will initiate a shutdown alarm.
16	Temperature Sensor Open Circuit	When the controller detects that the temperature sensor is open circuit and the action select "Shutdown", it will initiate a shutdown alarm.
17	High Temperature	When the controller detects that engine temperature has exceeded the pre-set value, it will initiate a shutdown alarm.
18	Oil Pressure Open Circuit	When the controller detects that the oil pressure sensor is open circuit and the action select "Shutdown", it will initiate a shutdown alarm.



No	Type	Description
19	Low Oil Pressure	When the controller detects that the oil pressure has fallen below the pre-set value, it will initiate a shutdown alarm.
20	Level Sensor Open Circuit	When the controller detects that the level sensor is open circuit and the action select "Shutdown", it will initiate a shutdown alarm.
21	Flexible Sensor 1 Open Circuit	When the controller detects that the flexible sensor 1 is open circuit and the action select "Shutdown", it will initiate a shutdown alarm.
22	Flexible Sensor 1 High	When the controller detects that the sensor 1 value has exceeded the pre-set value, it will initiate a shutdown alarm.
23	Flexible Sensor 1 Low	When the controller detects that the sensor 1 value has fallen below the pre-set value, it will initiate a shutdown alarm.
24	Flexible Sensor 2 Open Circuit	When the controller detects that the flexible sensor 2 is open circuit and the action select "Shutdown", it will initiate a shutdown alarm.
25	Flexible Sensor 2 High	When the controller detects that the sensor 2 value has exceeded the pre-set value, it will initiate a shutdown alarm.
26	Flexible Sensor 2 Low	When the controller detects that the sensor 2 value has fallen below the pre-set value, it will initiate a shutdown alarm.
27	Digital Input	When digit input port is set as shutdown and the alarm is active, it will initiate a shutdown alarm.
28	Earth Fault	If earth fault detection is enabled, when the controller detects that the earth fault current has exceeded the pre-set value and the action select "Shutdown", it will initiate a shutdown alarm.
29	Negative Sequence Current	When the controller detects the imbalance current has exceeded the pre-set value and the action select "Shutdown" it will initiate a shutdown alarm.
30	MSC Too Few Sets	When the controller detects fewer modules on the MSC link than the minimum number configured in the unit, it will initiate a shutdown alarm. There are 2 possible reasons: a) Communication line between the controllers disconnects, which interrupts communication. b) Other parallel gen-sets controllers have not been powered on.
31	MSC ID Error	When the controller detects the same ID on the MSC Bus, it will initiate a shutdown alarm.
32	Gen Phase Sequence Wrong	When the controller detects a phase rotation error, it will initiate a shutdown alarm.
33	Bus Phase Sequence Wrong	When the controller detects a bus phase rotation error, it will initiate a shutdown alarm.
34	Bus Error	When the controller detects the voltage difference between generator and bus, it will initiate a shutdown alarm.
35	Loss of Excitation	When the controller detects that the genset negative reactive power has exceeded the pre-set value, it will initiate a shutdown alarm.
36	Low Coolant Level	Controller initiate shutdown alarm after digital input port been configured as coolant level low shutdown (is active).
37	Detonation Shutdown	Controller initiate shutdown alarm after digital input port been configured as detonation shutdown (is active).
38	Gas Leak Shutdown	Controller initiate shutdown alarm after digital input port been configured as gas leak shutdown (is active).

6.3 TRIP AND STOP ALARMS

On initiation of the trip and stop condition the controller will de-energize the 'Close Generator' Output to remove the load from the generator. Once this has occurred the controller will start the Cooling delay and allow the engine to cool before shutting down the engine.

No	Type	Description
1	Gen Over Current	When the controller detects that the genset current has exceeded the pre-set value and the action select "Trip and Stop", it will initiate a trip and stop alarm.
2	Maintenance Due	When count down time is 0 and the action select "Trip and Stop", it will initiate a trip and stop alarm.
3	Reverse Power	If reverse power detection is enabled, when the controller detects that the reverse power value (power is negative) has fallen below the pre-set value and the action select "Trip and Stop", it will initiate a trip and stop alarm.
4	Over Power	If over power detection is enabled, when the controller detects that the over power value (power is positive) has exceeded the pre-set value and the action select "Trip and Stop", it will initiate a trip and stop alarm.
5	Digital Input	When digit input port is set as "Trip and Stop" and the alarm is active, it will initiate a trip and stop alarm.
6	Earth Fault	If earth fault detection is enabled, when the controller detects that the earth fault current has exceeded the pre-set value and the action select "Trip and Stop", it will initiate a trip and stop alarm.
7	Negative Sequence Current	When the controller detects the imbalance current has exceeded the pre-set value and the action select "Trip and Stop", it will initiate a trip and stop alarm.
8	Loss of Excitation	When the controller detects that the genset negative reactive power has exceeded the pre-set value, it will initiate a trip and stop alarm.
9	Mains Over Freq	When the controller detects that the mains frequency has exceeded the pre-set value, it will initiate a trip and stop alarm.
10	Mains Under Freq	When the controller detects that the mains frequency has fallen below the pre-set value, it will initiate a trip and stop alarm.
11	Mains Over Voltage	When the controller detects that the mains voltage has exceeded the pre-set value, it will initiate a trip and stop alarm.
12	Mains Under Voltage	When the controller detects that the mains voltage has fallen below the pre-set value, it will initiate a trip and stop alarm.
13	Mains ROCOF	When the controller detects that the ROCOF (rate of change of frequency) has exceeded the pre-set value, it will initiate a trip and stop alarm.
14	Mains Vector Shift	When the controller detects that vector shift value has exceeded the pre-set value, it will initiate a trip and stop alarm.

6.4 TRIP ALARM

On initiation of the trip condition the controller will de-energize the 'Close Generator' Output without stop the generator.

Trip alarm as following,

No	Type	Description
1	Gen Over Current	When the controller detects that the genset current has exceeded the pre-set value and the action select "Trip", it will initiate a trip alarm.
2	Reverse Power	If reverse power detection is enabled, when the controller detects that the reverse power value (power is negative) has fallen below the pre-set value and the action select "Trip", it will initiate a trip alarm.
3	Over Power	If over power detection is enabled, when the controller detects that the over power value (power is positive) has exceeded the pre-set value and the action select "Trip", it will initiate a trip alarm.
4	Digital Input	When digit input port is set as "Trip" and the alarm is active, it will initiate a trip alarm.
5	Earth Fault	If earth fault detection is enabled, when the controller detects that the earth fault current has exceeded the pre-set value and the action select "Trip", it will initiate a trip alarm.
6	Negative Sequence Current	When the controller detects the imbalance current has exceeded the pre-set value and the action select "Trip", it will initiate a trip alarm.
7	Loss of Excitation	When the controller detects that the genset negative reactive power has exceeded the pre-set value, it will initiate a trip alarm.

7 WIRING CONNECTION

HGM9510 controller's rear as following:

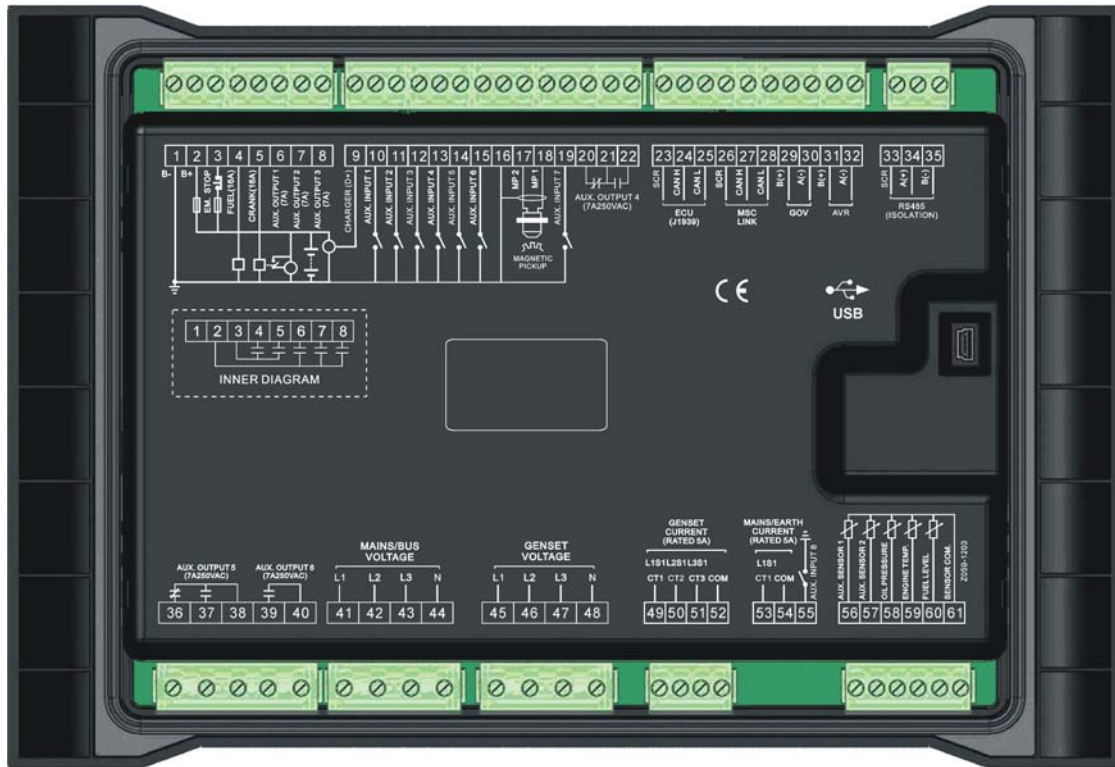

Description of terminal connection:

NO.	Functions	Cable Size	Remark	
1	B-	2.5mm ²	Connected with negative of starter battery.	
2	B+	2.5mm ²	Connected with positive of starter battery. If wire length is over 30m, better to double wires in parallel. Max. 20A fuse is recommended.	
3	Emergency stop	2.5mm ²	Connected with B+ via emergency stop button.	
4	Fuel relay	1.5mm ²	B+ is supplied by 3 points, rated 16A	
5	Crank	1.5mm ²	B+ is supplied by 3 points, rated 16A	Connected to starter coil Details see form 2
6	Aux. output 1	1.5mm ²	B+ is supplied by 2 points, rated 7A	
7	Aux. output 2	1.5mm ²	B+ is supplied by 2 points, rated 7A	
8	Aux. output 3	1.5mm ²	B+ is supplied by 2 points, rated 7A	
9	Charger (D+)	1.0mm ²	Connected with charger's D+ (WL) terminals. Be hanging in the air If there is no this terminal.	
10	Aux. input 1	1.0mm ²	Ground connected is active (B-)	Details see form 3
11	Aux. input 2	1.0mm ²	Ground connected is active (B-)	
12	Aux. input 3	1.0mm ²	Ground connected is active (B-)	
13	Aux. input 4	1.0mm ²	Ground connected is active (B-)	
14	Aux. input 5	1.0mm ²	Ground connected is active (B-)	
15	Aux. input 6	1.0mm ²	Ground connected is active (B-)	
16	Magnetic Pickup	0.5mm ²	Connected with Speed sensor, shielding line is	

NO.	Functions	Cable Size	Remark	
17	MP2		recommended. (B-) has already connected with speed sensor 2.	
18	MP1			
19	Aux. input 7	1.0mm ²	Ground connected is active (B-)	Details see form 3
20	Aux. output 4	1.5mm ²	Normally close outputs, rated 7A	Details see Form 2
21			Public points of relay	
22			Normally open outputs, rated 7A	
23	ECU CAN COM(GND)	/	Impedance-120Ω shielding wire is recommended, its single-end earthed.	
24	ECU CAN H	0.5mm ²		
25	ECU CAN L	0.5mm ²		
26	MSC CAN COM(GND)	/	Impedance-120Ω shielding wire is recommended, its single-end earthed.	
27	MSC CAN H	0.5mm ²		
28	MSC CAN L	0.5mm ²		
29	GOV B(+)	0.5mm ²	Shielding line is recommended. Shielding layer connect to earth at GOV end.	
30	GOV A(-)	0.5mm ²		
31	AVR B(+)	0.5mm ²	Shielding line is recommended. Shielding layer connect to earth at AVR end.	
32	AVR A(-)	0.5mm ²		
33	RS485 COM (GND)	/	Impedance-120Ω shielding wire is recommended, its single-end earthed.	
34	RS485-	0.5mm ²		
35	RS485+	0.5mm ²		
36	Aux. output 5	2.5mm ²	Normally close outputs, rated 7A	Details see form 2
37		2.5mm ²	Normally open outputs, rated 7A	
38		2.5mm ²	Public points of relay	
39		2.5mm ²	Normally open outputs, rated 7A	
40		2.5mm ²	Public points of relay	
41	Bus A-phase voltage input	1.0mm ²	Connected to A-phase of bus (2A fuse is recommended)	
42	Bus B-phase voltage input	1.0mm ²	Connected to B-phase of bus (2A fuse is recommended)	
43	Bus C-phase voltage input	1.0mm ²	Connected to C-phase of bus (2A fuse is recommended)	
44	Bus N-wire input	1.0mm ²	Connected to N-wire of bus	
45	Gen-set A-phase voltage input	1.0mm ²	Connected to A-phase of gen-set (2A fuse is recommended)	
46	Gen-set B-phase voltage input	1.0mm ²	Connected to B-phase of gen-set (2A fuse is recommended)	
47	Gen-set C-phase voltage input	1.0mm ²	Connected to C-phase of gen-set (2A fuse is recommended)	
48	Gen-set N-wire input	1.0mm ²	Connected to N-wire of gen-set	
49	CT A-phase input	1.5mm ²	Outside connected to secondary coil of current transformer(rated 5A)	

NO.	Functions	Cable Size	Remark
50	CT B-phase input	1.5mm ²	Outside connected to secondary coil of current transformer(rated 5A)
51	CT C-phase input	1.5mm ²	Outside connected to secondary coil of current transformer(rated 5A)
52	CT COM	1.5mm ²	See following installation instruction
56	Aux. sensor 1	1.0mm ²	Connect to temperature, oil pressure or fuel level sensors. Details see form 4
57	Aux. sensor 2	1.0mm ²	
58	Oil pressure	1.0mm ²	
59	Engine Temp.	1.0mm ²	
60	Fuel level	1.0mm ²	
61	Sensor COM	/	A public terminal of sensor, (B-) has already connected internal.

NOTE: USB ports in controller rear panel are configurable parameter ports, user can directly program controller via PC.

NOTE: Please refer to the [Modules Comparison](#) in this manual for more products' functions.

8 SCOPES AND DEFINITIONS OF PROGRAMMABLE PARAMETERS

8.1 CONTENTS AND SCOPES OF PARAMETERS

Form 1

No.	Items	Parameters	Defaults	Description
Timer Setting				
1	Start Delay	(0~3600)s	5	Time from mains abnormal or remote start signal is active to start genset.
2	Stop Delay	(0~3600)s	30	Time from mains normal or remote start signal is inactive to stop genset.
3	Preheat Delay	(0~3600)s	0	Time of pre-powering heat plug before starter is powered up.
4	Cranking Time	(3~60)s	8	Time of starter power on
5	Crank Rest Time	(3~60)s	10	The waiting time before second power up when engine start fail.
6	Safety On Delay	(0-3600)s	10	Alarms for low oil pressure, high temperature, under speed, under frequency /voltage, charge fail are inactive.
7	Start Idle Time	(0~3600)s	10	Idle running time of genset when starting.
8	Warming Up Time	(0~3600)s	30	Warming up time between genset switch on and high speed running.
9	Cooling Time	(0~3600)s	60	Radiating time before genset stop, after



No.	Items	Parameters	Defaults	Description
				it unloads.
10	Stop Idle Time	(0~3600)s	10	Idle running time when genset stop.
11	ETS Solenoid Hold	(0~3600)s	20	Stop electromagnet's power on time when genset is stopping.
12	Fail to Stop Delay	(0~3600)s	0	Time between ending of genset idle delay and stopped when "ETS time" is set as 0; Time between ending of ETS hold delay and stopped when "ETS Hold output time" is not 0.
13	After Stop Time	(0~3600)s	0	Time between genset stopped and standby.
14	Gas Engine Timers Enable	(0-1)	0	0: Enable 1:Disable When gas engine timer enabled, fuel oil output is used for controlling gas valve.
15	Choke On Time	(0-60)s	0	Gas choke on control output time when start engine.
16	Gas On Delay	(0-60)s	0	When engine started, it starts to output after the preset time delay.
17	Ignition Off Delay	(0-60)s	0	When gas valve closed, it stop to output after the preset delay.
Engine Setting				
1	Engine Type	(0~39)	0	Default: Conventional Engine(not J1939) When connected to J1939 engine, choose the corresponding type.
2	Flywheel Teeth	(10~300)	118	Tooth number of the engine, for judging of starter separation conditions and inspecting of engine speed. See the installation instructions.
3	Rated Speed	(0~6000)RPM	1500	Offer standard to judge over/under/loading speed.
4	Loading Speed	(0~100)%	90	Setting value is percentage of rated speed. Controller detects when it is ready to load. It won't switch on when speed is under loading speed.
5	Loss of Speed Signal	(0~3600)s	5	Time from detecting speed is 0 to confirm the action.
6	Loss of Speed Signal Action	(0~1)	0	0:Warn; 1:Shutdown
7	Over Shutdown Speed	(0~200)%	114	Setting value is percentage of rated speed and delay value (default: 2s) also can be set.
8	Under Shutdown Speed	(0~200)%	80	Setting value is percentage of rated speed and delay value (default: 3s) also can be

No.	Items	Parameters	Defaults	Description
				set.
9	Over Speed Warn	(0~200)%	110	Setting value is percentage of rated speed, delay value (default: 5s) and return value (default: 108%) also can be set.
10	Under Speed Warn	(0~200)%	86	Setting value is percentage of rated speed, delay value (default: 5s) and return value (default: 90%) also can be set.
11	Battery Rated Voltage	(0~60.0)V	24.0	Standard for detecting of over/under voltage of battery.
12	Battery Over Volts	(0~200)%	120	Setting value is percentage of rated voltage of battery, delay value (default: 60s) and return value (default: 115%) also can be set.
13	Battery Under Volts	(0~200)%	85	Setting value is percentage of rated voltage of battery, delay value (default: 60s) and return value (default: 90%) also can be set.
14	Charge Alt Fail	(0~60.0)V	8.0	In normal running, when charger D+(WL) voltage under this value, charge failure alarms. Delay value (default: 10s) and return value (default: 10.0V) also can be set.
15	Start Attempts	(1~10) times	3	Max. Crank times of crank attempts. When reach this number, controller will send start failure signal.
16	Crank Disconnect	(0~6)	2	See form 5 There are 3 conditions of disconnecting starter with engine. Each condition can be used alone and simultaneously to separating the start motor and genset as soon as possible.
17	Disconnect Generator Freq	(0~200)%	30	When generator frequency higher than the set value, starter will be disconnected. See the installation instruction.
18	Disconnect Engine Speed	(0~200)%	30	When generator speed higher than the set value, starter will be disconnected. See the installation instruction.
19	Disconnect Oil Pressure	(0~1000)kPa	200	When generator oil pressure higher than the set value, starter will be disconnected. See the installation instruction.
Generator Setting				
1	AC System	(0~3)	0	0: 3P4W; 1: 3P3W; 2: 2P3W; 3: 1P2W.
2	Poles	(2-32)	4	Numbers of generator pole, used for



No.	Items	Parameters	Defaults	Description
				calculating starter rotate speed when without speed sensor.
3	Rated Voltage	(30~30000)V	230	To offer standards for detecting of gens' over/under voltage and loading voltage. (It is primary voltage when using voltage transformer; it is line voltage when AC system is 3P3W while it is phase voltage when using other AC system).
4	Loading Voltage	(0~200)%	90	Setting value is percentage of generator rated voltage. When gens voltage under load voltage, won't enter into normally running, during the period of when controller ready to detect loading.
5	Rated Frequency	(10.0-75.0)Hz	50.0	To offer standards for detecting of over/under/load frequency.
6	Loading Frequency	(0~200)%	90	Setting value is percentage of generator rated frequency. When generator frequency under load frequency, it won't enter into normal running.
7	Volt. Trans.(PT)	(0~1)	0	0: Disable; 1:Enable
8	Over Shutdown Volt.	(0~200)%	120	Setting value is percentage of generator rated volt. Delay value (default: 3s) also can be set.
9	Under Shutdown Volt.	(0~200)%	80	Setting value is percentage of generator rated volt. Delay value (default: 2s) also can be set.
10	Over Shutdown Freq.	(0~200)%	114	Setting value is percentage of generator rated freq. Delay value (default: 2s) also can be set.
11	Under Shutdown Freq.	(0~200)%	80	Setting value is percentage of generator rated freq. Delay value (default: 3s) also can be set.
12	Over Volt. Warn	(0~200)%	110	Setting value is percentage of generator rated volt. Delay value (default: 5s) and return value (default: 108%) can be set.
13	Under Volt. Warn	(0~200)%	84	Setting value is percentage of generator rated volt. Delay value (default: 5s) and return value (default: 86%) also can be set.
14	Over Freq. Warn	(0~200)%	110	Setting value is percentage of gens rated freq. Delay value (default: 5s) and return value (default: 108%) also can be set.
15	Under Freq. Warn	(0~200)%	84	Setting value is percentage of gens rated freq. Delay value (default: 5s) and return value (default: 86%) also can be set.
16	Loss of Phase	(0~1)	1	0: Disable 1: Enable
17	Phase Sequence	(0~1)	1	



No.	Items	Parameters	Defaults	Description
	Wrong			
Generator Load Setting				
1	Current Trans.	(5~6000)/5	500	The ratio of external CT
2	Full Current Rating	(5~6000)A	500	Generator's rated current, standard of load current.
3	Full kW rating	(0-20000)kW	276	Generator's rated power, standard of load power.
4	Over Current	(0~200)%	120	Setting value is percentage of generator rated volt. Delay value also can be set.
5	Over Power	(0~200)%	110	Setting value is percentage of generator rated active power. Delay value (default: 30s) and action (default: trip and stop) can be set.
6	Reverse Power	(0~200)%	10	Setting value is percentage of generator rated active power. Delay value (default: 10s) and action (default: trip and stop) can be set.
7	Earth Fault	(0~1)	0	0: Disable 1: Enable.
8	Negative Sequence Current	(0~1)	0	0: Disable 1: Enable.
9	Loss of Excitation	(0~200)%	20	Setting value is percentage of generator rated reactive power. Delay value (default: 5s) and action (default: trip) can be set.
Switch Setting				
1	Close Time	(0~20.0)s	5.0	Pulse width of mains/generator switch on. When it is 0, means output constantly.
2	Open Time	(0~20.0)s	3.0	Pulse width of mains/ generator switch off.
Module Setting				
1	Power On Mode	(0~2)	0	0: Stop mode 1: Manual mode 2: Auto mode
2	Module Address	(1~254)	1	Controller's address during remote sensing.
3	Stop Bit	(0~1)	0	0: 2 stop bits; 1: 1 stop bit
4	Language	(0~2)	0	0: Simplified Chinese 1: English 2: Others
5	Password	(0~65535)	00318	For entering advanced parameters setting.
6	Date and Time			Set the module's date and time.
Scheduling And Maintenance Setting				
1	Scheduled Run	(0~1)	0	0: Disable; 1: Enable
2	Scheduled Not Run	(0~1)	0	0: Disable; 1: Enable



No.	Items	Parameters	Defaults	Description
3	Maintenance	(0~1)	0	0: Disable; 1: Enable
Analog Sensors Setting				
Temperature Sensor				
1	Curve Type	(0~15)	7	SGX See form 4.
2	Open Circuit Action	(0~2)	0	0: Warn 1: Shutdown 2: No action
3	High Temp. Shutdown	(0-300)°C	98	Shutdown when sensor temperature higher than this value. Detecting only after safety delay is over. The delay value (default: 3s) also can be set.
4	High Temp Warn	(0-300)°C	95	Warn when sensor temperature higher than this value. Detecting only after safety delay is over. The delay value (default: 5s) and return value (default: 93) also can be set.
5	Low Temp. Warn	(0~1)	0	0: Disable; 1: Enable
Oil Pressure Sensor				
1	Curve Type	(0~15)	7	SGX See form 4.
2	Open Circuit Action	(0~2)	0	0: Warn 1: Shutdown 2: No action
3	Low OP Shutdown	(0~1000)kPa	103	Shutdown when oil pressure higher than this value. Detecting only after safety delay is over. The delay value (default: 3s) also can be set.
4	Low OP Warn	(0~1000)kPa	124	Warn when oil pressure lower than this value. Detecting only after safety delay is over. The delay value (default: 5s) and return value (default: 138) also can be set.
Liquid Level Sensor				
1	Curve Type	(0~15)	0	Not used. See form 4
Flexible Sensor 1				
1	Flexible Sensor 1 Setting	(0~1)	0	0: Disable 1: Enable; (can be set as temperature/pressure/liquid level sensor).
Flexible Sensor 2				
1	Flexible Sensor 2 Setting	(0~1)	0	0: Disable; 1: Enable; (can be set as temperature/pressure/liquid level sensor).
Flexible Input Ports				
Flexible Input Port 1				
1	Contents Setting	(0~60)	31	Remote start (demand). See form 3
2	Active Type	(0~1)	0	0: Closed to active 1: Open to active
Flexible Input Port 2				
1	Contents Setting	(0~60)	27	Low oil pressure shutdown



No.	Items	Parameters	Defaults	Description
				See form 3
2	Active Type	(0~1)	0	0: Closed to active 1: Open to active
Flexible Input Port 3				
1	Contents Setting	(0~60)	26	High temperature shutdown See form 3
2	Active Type	(0~1)	0	0: Closed to active 1: Open to active
Flexible Input Port 4				
1	Contents Setting	(0~60)	13	Gen Closed. See form 3
2	Active Type	(0~1)	0	0: Closed to active 1: Open to active
Flexible Input Port 5				
1	Contents Setting	(0~60)	0	User defined. See form 3
2	Active Type	(0~1)	0	0: Closed to active 1: Open to active
3	Arming	(0~3)	3	0: From safety on 1: From starting 2: Always 3:Never
4	Active Actions	(0~4)	4	0: Warn; 1: Shutdown; 2:Trip and stop 3:Trip 4: Indication
5	Active Delay	(0~20.0)s	2.0	Time from detecting active to confirm
6	Description			LCD display detailed contents when the input is active.
Flexible Input Port 6				
1	Contents Setting	(0~60)	44	First priority. See form 3
2	Active Type	(0~1)	0	0: Closed to active 1: Open to active
Flexible Input Port 7				
1	Contents Setting	(0~60)	0	User defined. See form 3
2	Active Type	(0~1)	0	0: Closed to active 1: Open to active
3	Arming	(0~3)	3	0: From safety on 1: From starting 2: Always 3:Never
4	Active Actions	(0~4)	4	0: Warn; 1: Shutdown; 2:Trip and stop 3:Trip 4: Indication
5	Active Delay	(0~20.0)s	2.0	Time from detecting active to confirm
6	Description			LCD display detailed contents when the input is active.
Flexible Output Ports				
Flexible Output Port 1				
1	Contents Setting	(0~299)	44	Generator OK. See Form 2
2	Active Type	(0~1)	0	0:Normally open; 1:Normally close
Flexible Output Port 2				
1	Contents Setting	(0~299)	48	Common Alarm. See Form 2



No.	Items	Parameters	Defaults	Description
2	Active Type	(0~1)	0	0:Normally open; 1:Normally close
Flexible Output Port 3				
1	Contents Setting	(0~299)	38	Energise to Stop. See form 2
2	Active Type	(0~1)	0	0:Normally open; 1:Normally close
Flexible Output Port 4				
1	Contents Setting	(0~299)	35	Idle Control. See form 2
2	Active Type	(0~1)	0	0:Normally open; 1:Normally close
Flexible Output Port 5				
1	Contents Setting	(0~299)	30	Open Gen Output. See form 2
2	Active Type	(0~1)	0	0:Normally open; 1:Normally close
Flexible Output Port 6				
1	Contents Setting	(0~299)	29	Close Gen Output. See form 2
2	Active Type	(0~1)	0	0:Normally open; 1:Normally close
Sync Setting -Basic				
1	Dead Bus Volt	(10-50)V	30	It is considered Bus no power when Bus voltage is lower than dead Bus voltage.
2	Voltage Difference	(0-30)V	3	It is considered voltage synchronization when the voltage difference between Generator and Bus is lower than synchronization voltage difference.
3	Positive Freq Difference	(0-2.0)Hz	0.2	It is considered frequency synchronization when the frequency difference between Generator and Bus is less than Check Up Freq but more than Check Low Freq .
4	Negative Freq Difference	(0-2.0)Hz	0.1	
5	Phase Angle Difference	(0-20)°	10	It is considered Check Phase Angle when the initial phase difference is lower than synchronization phase difference.
6	Slip Frequency Sync	(0-1.00)Hz	0.10	Adjust generator frequency and enable it greater than Bus frequency.
7	MSC ID	(0-31)	1	It is the ID mark of the MSC communication internet. All the MSC ID should be unique.
8	MSC Priority	(0-31)	0	Smaller values represent higher priorities.
9	Full kW rating	(0-20000)kW	276	Used for load sharing.
10	Full kVar rating	(0-20000)kvar	210	Used for load sharing.
11	Baud Rate	(0-3)	1	0: 500kbps; 1: 250kbps; 2: 125kbps; 3: 50kbps.
12	Scheduled Run	(0-100)%	80	Schedule the load value of other genset



No.	Items	Parameters	Defaults	Description
	PCT			when start on demand.
13	Scheduled Stop PCT	(0-100)%	50	Schedule the load value of other genset when start on demand.
14	Load Ramp Rate	(0.1-100.0)%	3.0	Speed rate(%/s) of genset upload/unload
15	Load Ramp Point	(0.1-40.0)%	10.0	
16	Load Ramp Delay	(0-30)s	0	
17	Starting Options	(0-1)	1	0: Start All Sets; 1: Start Sets as Load Requires
18	MSC Modules	(2-10)	2	Action Type: 0: No Action; 1: Warn; 2: Trip.
19	MSC Too Few Modules Action Type	(0-2)	1	
20	Balance Engine Hours	(1-1000)Hours	Disable	When the input is active, the controller will start/stop the genset automatically according to the running time and the pre-set balanced running time.
21	Fail to Sync Delay	(5.0-300.0)s	60.0	When the controller detects no Sync signal during the preset delay, it will send corresponding alarm signal according to the action type. Action Type: 0: Warn; 1: Trip.
22	Fail to Sync Action	(0-1)	0	
23	NEL (Load Shedding) Trip	(0-1)	0	0: Disable 1: Enable; Details of function description please see the following.
24	NEL Trip 1 Set Value	(0-200)%	90%	
25	NEL Trip 1 Delay	(0-3600)s	5	
26	NEL Trip 2 Set Value	(0-200)%	100%	
27	NEL Trip 2 Delay	(0-3600)s	1	
28	NEL Auto Reconnection	(0-1)	0	
29	NEL Auto Reconnection Set Value	(0-200)%	50%	
30	NEL Auto Reconnection Delay	(0-3600)s	5	
31	NEL Load Shedding Number	(1-3)	3	
Sync Setting - GOV				
1	Output Type	(0-1)	1	0: Relay output; 1: Analog Voltage Output
2	Output Reverse	(0-1)	0	0: Disable; 1: Enable.



No.	Items	Parameters	Defaults	Description
3	Action	(0-2)	1	0: None; 1: Adjust to Rated Frequency; 2: Adjust to Center Point
4	Center Voltage SW1	(0-10.0)	0	Default central voltage: 0V.
5	Voltage Range SW2	(0-10.0)	2.0	Default volt. range: (-2.5~+2.5)V
6	Sync Gain	(0-500)	20	Adjust and control before paralleling.
7	Sync Stability	(0-2000)	20	Adjust and control before paralleling.
8	Load Gain	(0-500)	20	Adjust and control after paralleling.
9	Load Stability	(0-2000)	20	Adjust and control after paralleling.
Sync Setting - AVR				
1	Output Type	(0-1)	1	0: Relay output; 1: Analog Voltage Output
2	Output Reverse	(0-1)	0	0: Disable; 1: Enable.
3	Action	(0-2)	1	0: None; 1: Adjust to Rated Frequency; 2: Adjust to Center Point
4	Center Voltage SW1	(0-10.0)	0	Default central voltage: 0V.
5	Voltage Range SW2	(0-10.0)	2.0	Default volt. range: (-2.5~+2.5)V
6	Sync Gain	(0-500)	20	Adjust and control before paralleling.
7	Sync Stability	(0-2000)	20	Adjust and control before paralleling.
8	Load Gain	(0-500)	20	Adjust and control after paralleling.
9	Load Stability	(0-2000)	20	Adjust and control after paralleling.
Mains Split Setting				
1	AC System	(0~3)	0	0: 3P4W; 1: 3P3W; 2: 2P3W; 3: 1P2W.
2	Rated Voltage	(30~30000)V	230	To offer standards for detecting of mains' over/under voltage and loading voltage. (It is primary voltage when using voltage transformer; it is line voltage when AC system is 3P3W while it is phase voltage when using other AC system).
3	Mains Rated Frequency	(10.0~75.0)Hz	50.0	To offer standards for detecting of over/under/load frequency.
4	Volt. Trans.(PT)	(0-1)	0	0: Disable ; 1: Enable
5	Mains Voltage Over	(0-200)%	105%	Setting value is percentage of mains rated volt. Delay value (default: 0.1s) and alarm action (default: trip and stop) also can be set.
6	Mains Voltage Under	(0-200)%	95%	
7	Mains Frequency Over	(0-200)%	105%	Setting value is mains rated frequency's percentage. Delay value(default: 0.1s) and alarm action (default: trip and stop) also can be set.
8	Mains Frequency Under	(0-200)%	95%	

No.	Items	Parameters	Defaults	Description
9	ROCOF	(0-1.00)Hz/s	0.20	Setting value is mains' rate of change of frequency, and alarm action (default: trip and stop) and delay value (default: 0.1s) also can be set.
10	Vector Shift	(0-20.0)°	6.0	Setting value is phase angle's change rate of mains voltage waveform, and alarm action (default: trip and stop) and delay value (default: 0.1s) also can be set.

▲Note: overcurrent setting details about definite time delay and inverse definite minimum time.

Definite Time : overcurrent delay is definite time delay. Different overcurrent value has corresponding delay.

Inverse Definite Minimum Time(IDMT) : overcurrent delay decrease with the increase of overcurrent. Different overcurrent value has corresponding delay.

IDMT formula:

$$T = t / ((IA/IT)-1)^2$$

T: Overcurrent delay (second)

t: Timing multiplier ratio

IA: Current max. load current (L1/L2/L3)

IT: Overcurrent setting value

Example:

$$t = 36$$

$$IA = 550A$$

$$IT = 500A$$

Conclusion: T = 3600s(1hour)

8.2 ENABLE DEFINITION OF PROGRAMMABLE OUTPUT PORTS

Form 2

No.	Type	Description
0	Not Used	
1	Custom Period 1	Details of function description please see the following.
2	Custom Period 2	
3	Custom Period 3	
4	Custom Period 4	
5	Custom Period 5	
6	Custom Period 6	
7	Custom Combined 1	
8	Custom Combined 2	
9	Custom Combined 3	
10	Custom Combined 4	
11	Custom Combined 5	
12	Custom Combined 6	
13	Reserved	
14	Reserved	
15	Gas Choke On	Action while cranking. Action time is as pre-seted.
16	Gas Ignition	Action when genset starting, and disconnect when engine stopped.
17	Air Flap Control	Action when over speed shutdown and emergence stop. It also can close the air inflow to stop the engine as soon as possible.
18	Audible Alarm	Action when warning, shutdown, trips. Can be connected annunciator externally. When "alarm mute" configurable input port is active, it can remove the alarm.
19	Louver Control	Action when genset starting and disconnect when genset stopped completely.
20	Fuel Pump Control	It is controlled by fuel pump of level sensor's limited threshold.
21	Heater Control	It is controlled by heating of temperature sensor's limited threshold.
22	Cooler Control	It is controlled by cooler of temperature sensor's limited threshold.
23	Oil Pre-supply Output	Action from "crank on" to "safety on".
24	Generator Excite	Output in start period. If there is no generator frequency during hi-speed running, output for 2 seconds again.
25	Pre-Lubricate	Actions in period of pre-heating to safety run.
26	Remote Control Output	This port is controlled by communication (PC).
27	Reserved	
28	Reserved	
29	Close Gen Output	Control generator to take load.
30	Open Gen Output	Control generator to off load.

31	Reserved	
32	Reserved	
33	Start Relay	
34	Fuel Relay	Action when genset is starting and disconnect when stop is completed. When gas timer enabled, fuel oil relay output is used for controlling gas valve.
35	Idle Control	Used for engine which has idles. Close before starting and open in warming up delay; Close during stopping idle mode and open when stop is completed.
36	Speed Raise Relay	Action in warming up delay.
37	Speed Drop Relay	Action between the period from “stop idle” to “failed to stop”.
38	Energize to Stop	Used for engines with ETS electromagnet. Close when stop idle is over and open when pre-set “ETS delay” is over.
39	Speed Drop Pulse	Active 0.1s when controller enter into stop idle, used for control part of ECU dropping to idle speed.
40	ECU Stop	Used for ECU engine and control its stop.
41	ECU Power Supply	Used for ECU engine and control its power.
42	Speed Raise Pulse	Active 0.1s when controller enter into warming up delay; used for control part of ECU raising to normal speed.
43	Crank Success	Close when detects a successful start signal.
44	Generator OK	Action when generator is normal.
45	Generator Load Available	Action in period of generator ok to hi-speed cooling.
46	Reserved	
47	Synchronizing	Action when controller is synchronizing.
48	Common Alarm	Action when genset common warning, common shutdown, common trips alarm.
49	Common Trip and Stop	Action when common trip and stop alarm.
50	Common Shutdown	Action when common shutdown alarm.
51	Common Trip	Action when common trips alarm.
52	Common Warn	Action when common warning alarm.
53	Reserved	
54	Battery Over Voltage	Action when battery’s over voltage warning alarm.
55	Battery Under Voltage	Action when battery’s low voltage warning alarm.
56	Charge Alternator Failure	Action when charge fail warning alarms.
57	Reserved	
58	Reserved	
59	Reserved	
60	ECU Warning	Indicate ECU sends a warning signal.
61	ECU Shutdown	Indicate ECU sends a shutdown signal.
62	ECU Com Fail	Indicate controller not communicates with ECU.
63	PWM Voltage Raise	When output type of AVR set as “Relay output”, controller adjust voltage and reactive power via “Sync Raise Volt”
64	PWM Voltage Drop	

		and “Sync Drop Volt”
65	PWM Speed Raise	When output type of GOV set as “Relay output”, controller adjust speed and power via “Sync Raise Speed” and “Sync Drop Speed”
66	PWM Speed Drop	
67	Reserved	
68	Reserved	
69	Digital Input 1 Active	Action when input port 1 is active
70	Digital Input 2 Active	Action when input port 2 is active
71	Digital Input 3 Active	Action when input port 3 is active
72	Digital Input 4 Active	Action when input port 4 is active
73	Digital Input 5 Active	Action when input port 5 is active
74	Digital Input 6 Active	Action when input port 6 is active
75	Digital Input 7 Active	Action when input port 7 is active
76~80	Reserved	
81	Extend Digital Input 1 Active	
82	Extend Digital Input 2 Active	
83	Extend Digital Input 3 Active	
84	Extend Digital Input 4 Active	
85	Extend Digital Input 5 Active	
86	Extend Digital Input 6 Active	
87	Extend Digital Input 7 Active	
88	Extend Digital Input 8 Active	
89	Extend Digital Input 9 Active	
90	Extend Digital Input 10 Active	
91	Extend Digital Input 11 Active	
92	Extend Digital Input 12 Active	
93	Extend Digital Input 13 Active	
94	Extend Digital Input 14 Active	
95	Extend Digital Input 15 Active	
96	Extend Digital Input 16 Active	

97-98	Reserved	
99	Emergency Stop	Action when emergency stop alarm.
100	Fail To Start	Action when failed start alarm.
101	Fail To Stop	Action when failed stop alarm.
102	Under Speed Warn	Action when under speed alarm.
103	Under Speed Shutdown	Action when under speed shuts down.
104	Over Speed Warn	Action when over speed warn.
105	Over Speed Shutdown	Action when over speed shutdown alarm.
106	Reserved	
107	Reserved	
108	Reserved	
109	Gen Over Freq. Warn	Action when generator over frequency warning.
110	Gen over Freq. Shut	Action when generator over frequency shutdown alarm.
111	Gen Over Volt Warn	Action when generator over voltage warning.
112	Gen Over Volt Shut	Action when generator over voltage shutdown.
113	Gen Under Freq. Warn	Action when generator low frequency warning.
114	Gen Under Freq. Shut	Action when generator low frequency shutdown.
115	Gen Under Volt. Warn	Action when generator low voltage warning.
116	Gen Under Volt. Shut	Action when generator low voltage shutdown.
117	Gen Loss of Phase	Action when generator loss phase.
118	Gen Phase Sequence Wrong	Action when generator reverse phase.
119	Reserved	
120	Over Power	Action when controller detects generator have over power.
121	Reserved	
122	Generator Reverse Power	Action when controller detects generator have reverse power.
123	Over Current	Action when over current.
124-133	reserved	
134	NEL1 Trip	Details of function description please see the following.
135	NEL2 Trip	
136	NEL3 Trip	
137~138	Reserved	
139	High Temp Warn	Action when hi-temperature warning.
140	Low Temp Warn	Action when low temperature warning.
141	High Temp Shutdown	Action when hi-temperature Shutdown alarm.
142	Reserved	
143	Low OP Warn	Action when low oil pressure warning.
144	Low OP Shutdown	Action when low oil pressure shutdown.
145	Oil Pressure Open Circuit	Action when oil pressure sensor is open circuit.
146	Reserved	
147	Low Fuel Level	Action when controller has low oil level alarm.
148	Reserved	
149	Reserved	

150	Flexible Sensor 1 High Warn	
151	Flexible Sensor 1 Low Warn	
152	Flexible Sensor 1 High Shut	
153	Flexible Sensor 1 Low Shut	
154	Flexible Sensor 2 High Warn	
155	Flexible Sensor 2 Low Warn	
156	Flexible Sensor 2 High Shut	
157	Flexible Sensor 2 Low Shut	
158~229	Reserved	
230	Stop Mode	Action in stop mode.
231	Manual Mode	Action in Manual mode.
232	Reserved	
233	Auto Mode	Action in Auto mode.
234	Generator Load	
235~239	Reserved	
240~279	PLC Flag 1-40	
280~299	Reserved	

8.2.1 DEFINED PERIOD OUTPUT

Defined Period output is composed by 2 parts, period output S1 and condition output S2.



While S1 and S2 are **TRUE** synchronously, OUTPUT;

While S1 or S2 is **FALSE**, NOT OUTPUT.

Period output S1, can set generator's one or more period output freely, can set the delayed time and output time after enter into period.

Condition output S2; can set as any conditions in output ports.

▲NOTE: when delay time and output time both are 0 in period output S1, it is **TRUE** in this period.

Output period: start

Delay output time: 2s

Output time: 3s

Condition output contents: output port 1 is active

Close when condition output active/inactive: close when active (disconnect when inactive);

Output port 1 active, after enter "starts time" and delay 2s, this defined period output is outputting, after 3s, stop outputting;

Output port 1 inactive, defined output period is not outputting.

8.2.2 DEFINED COMBINATION OUTPUT

Defined combination output is composed by 3 parts, condition output S1 or S2 and condition output S3.

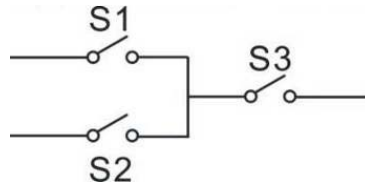

S1 or S2 is **TRUE**, while S3 is **TRUE**, Defined combination output is outputting;

S1 and S2 are **FALSE**, or S3 is **FALSE**, Defined combination output is not outputting.

NOTE: S1, S2, S3 can be set as any contents except for “defined combination output” in the output setting.

NOTE: 3 parts of defined combination output (S1, S2, S3) couldn't include or recursively include themselves.

Example,

Contents of probably condition output S1: output port 1 is active;

Close when probably condition output S1 is active /inactive: close when active (disconnect when inactive);

Contents of probably condition output S2, output port 2 is active;

Close when probably condition output S2 is active /inactive: close when active (disconnect when inactive);

Contents of probably condition output S3: output port 3 is active;

Close when probably condition output S3 is active /inactive: close when active (disconnect when inactive);

When input port 1 active or input port 2 active, if input port 3 is active, Defined combination output is outputting; If input port 3 inactive, Defined combination output is not outputting;

When input port 1 inactive and input port 2 inactive, whatever input port 3 is active or not, Defined combination output is not outputting.

8.3 DEFINED CONTENTS OF PROGRAMMABLE INPUT PORTS (ALL ACTIVE WHEN CONNECT TO GRAND (B~))

Form 3

No.	Type	Description
0	Users Configured	Including following functions, Indication: indicate only, not warning or shutdown. Warning: warn only, not shutdown. Shutdown: alarm and shutdown immediately Trip and stop: alarm, generator unloads and shutdown after hi-speed cooling Trip: alarm, generator unloads but not shutdown. Never: input inactive. Always: input is active all the time. From crank: detecting as soon as start. From safety on: detecting after safety on run delay.
1	Reserved	
2	Alarm Mute	Can prohibit "Audible Alarm" output when input is active.
3	Reset Alarm	Can reset shutdown alarm and trip alarm when input is active.
4	60HZ Active	Use for CANBUS engine and it is 60Hz when input is active.
5	Lamp Test	All LED indicators are illuminating when input is active.
6	Panel Lock	All buttons in panel is inactive except  and there is  in the left of first row in LCD when input is active.
7	Reserved	
8	Idle Control Mode	Under voltage/frequency/speed protection is inactive.
9	Inhibit Auto Stop	In Auto mode, during generator normal running, when input is active, prohibit generator shutdown automatically.
10	Inhibit Auto Start	In Auto mode, prohibit generator start automatically when input is active.
11	Inhibit Scheduled	In Auto mode, prohibit fixed timing start genset when input is active.
12	Reserved	
13	Aux Gen Closed	Connect generator loading switch's Aux. Point.
14	Inhibit Gen Load	Prohibit genset switch on when input is active.
15	Reserved	
16	Reserved	
17	Auto Mode Lock	When input is active, controller enters into Auto mode; all the keys except  are inactive.
18	Auto Mode Invalid	When input is active, controller won't work under Auto mode.  key and simulate auto key input does not work.



19	Static Parallel Mode	
20	Black-start	
21	Inhibit Alarm Stop	All shutdown alarms are prohibited except emergence stop.(Means battle mode or override mode)
22	Aux Instrument Mode	All outputs are prohibited in this mode.
23	Reserved	
24	Reset Maintenance	Controller will set maintenance time and date as default when input is active.
25	Reserved	
26	Aux. High Temp	Connected sensor digital input.
27	Aux. Low OP	Connected sensor digital input.
28	Remote Start (On Load)	In Auto mode, when input active, genset can be started and with load after genset is OK; when input inactive, genset will stop automatically.
29	Remote Start (Off Load)	In Auto mode, when input is active, genset can be started and without load after genset is OK; when input is inactive, genset will stop automatically.
30	Aux. Manual Start	In Auto mode, when input active, genset will start automatically; when input inactive, genset will stop automatically
31	Remote Start (On Demand)	In Auto mode, when input active, all genset that need to be parallel will start according to the priority and calling other generator according to the load.
32	Reserved	
33	Simulate Stop key	An external button can be connected and pressed as simulate panel.
34	Simulate Manual key	
35	Reserved	
36	Simulate Auto key	An external button can be connected and pressed as simulate panel.
37	Simulate Start key	
38	Simulate G-Load key	This is simulate G-close key when HGM9510 controller is applied.
39	Simulate M-Load key	This is simulate M-open key when HGM9510 controller is applied.
40	NEL Manual Trip	An external button (Not Self-locking) can be connected. Details of function description please see the following.
41	NEL Manual Recon	
42	Power Manager Mode	Power management mode will be displayed on the LCD when the input is active. In this mode, the controller will control genset synchronize, power sharing, scheduled start, scheduled stop, generator closed, generator opened but genset start or stop. Details of function description please see the following.
43	Mains Parallel Mode	The genset will output constant power when the input is active.
44	First Priority	It is the highest priority when the input is active. Used for main/standby genset selection.
45	Reserved	
46	Reserved	
47	Alternative Config1	Users can set different parameters to make it easy to select current configuration via input port.
48	Alternative Config2	

49	Alternative Config3	
50	Reserved	
51	Speed Up	
52	Speed Down	
53	Voltage Up	
54	Voltage Down	
55	Reserved	
56	Low Coolant Level	Connect with water level sensor digital input port.
57	Detonation Shutdown	Connect with detection module warn input port.
58	Gas Leak Shutdown	Connect with detection module warn input port.
59	Reserved	
60	Reserved	

8.4 SELECTION OF SENSORS

Form4

No.	Description	Remark
1	Temperature Sensor	0 Not used 1 Custom Res Curve 2 Custom 4-20mA curve 3 VDO 4 CURTIS 5 VOLVO-EC 6 DATCON 7 SGX 8 SGD 9 SGH 10 PT100 11 SUSUKI 12 PRO 13~15 Reserved Defined resistance's range is 0~6KΩ, default is SGX sensor.
2	Pressure Sensor	0 Not used 1 Custom Res Curve 2 Custom 4-20mA curve 3 VDO 10Bar 4 CURTIS 5 VOLVO-EC 6 DATCON 10Bar 7 SGX 8 SGD 9 SGH 10 VDO VDO 5Bar 11 DATCON 5Bar 12 DATCON 7Bar 13 SUSUKI 14 PRO 15 Reserved Defined resistance's range is 0~6KΩ, default is SGX sensor.
3	Oil Level Sensor	0 Not used 1 Custom Res Curve 2 Custom 4-20mA curve 3 SGD 4 SGH 5~15 Reserved Defined resistance's range is 0~6KΩ, default is SGH sensor.

NOTE: User should make special declare when order controller if your genset equip with sensor of 4~20mA.

8.5 CONDITIONS OF CRANK DINSCONNECT SELECTION

No.	Setting description
0	Gen frequency
1	Speed sensor
2	Speed sensor + Gen frequency
3	Oil pressure
4	Oil pressure + Gen frequency
5	Oil pressure + Speed sensor
6	Oil pressure + Speed sensor + Gen frequency

NOTE:

- There are 3 conditions to make starter disconnected with engine, that is, speed sensor, generator frequency and engine oil pressure. They all can be used separately. We recommend that engine oil pressure should be using with speed sensor and generator frequency together, in order to make the starter motor is separated with engine immediately and can check crank disconnect exactly.
- Speed sensor is the magnetic equipment which be installed in starter for detecting flywheel teeth.
- When set as speed sensor, must ensure that the number of flywheel teeth is as same as setting, otherwise, "over speed stop" or "under speed stop" may be caused.
- If genset without speed sensor, please don't select corresponding items, otherwise, "start fail" or "loss speed signal" maybe caused.
- If genset without oil pressure sensor, please don't select corresponding items.
- If not select generator frequency in crank disconnect setting, controller will not collect and display the relative power quantity (can be used in water pump set); if not select speed sensor in crank disconnect setting, the rotating speed displayed in controller is calculated by generator frequency and number of poles.

9 PARAMETERS SETTING

CAUTION: Please change the controller parameters when generator is in standby mode only (e. g. Start conditions selection, configurable input, configurable output, various delay), otherwise, alarming to stop and other abnormal conditions may happen.

NOTE: Maximum set value must over minimum set value in case that the condition of too high as well as too low will happen.

NOTE: When setting the warning alarm, please set the correct return value; otherwise, maybe there is abnormal alarm. When setting the maximum value, the return value must less than setting; when setting the minimum value, the return value must over setting.

NOTE: Please set the generator frequency value as low as possible when cranking, in order to make the starter be separated quickly as soon as crank disconnect.

NOTE: Configurable input could not be set as same items; otherwise, there are abnormal functions. However, the configurable output can be set as same items.

10 SENSORS SETTING

- 1) When reselect sensors, the sensor curve will be transferred into the standard value. For example, if temperature sensor is SGX (120°C resistor type), its sensor curve is SGX (120°C resistor type); if select the SGD (120°C resistor type), the temperature sensor curve is SGD curve.
- 2) When there is difference between standard sensor curves and using sensor, user can adjust it in “curve type”.
- 3) When input the sensor curve, X value (resistor) must be input from small to large, otherwise, mistake occurs.
- 4) If select sensor type as “None”, sensor curve is not working.
- 5) If corresponding sensor has alarm switch only, user must set this sensor as “None”, otherwise, maybe there is shutdown or warning.
- 6) The headmost or backmost values in the vertical coordinates can be set as same as below,

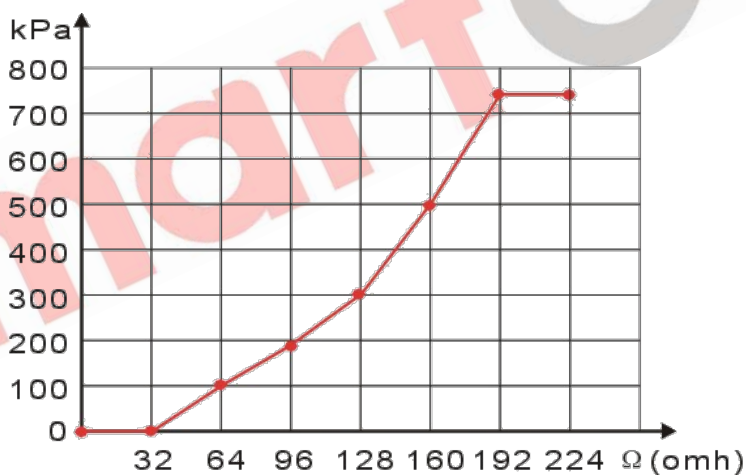

Normal Pressure Unit Conversion Form

	pa	kgf/cm ²	bar	psi
1Pa	1	1.02x10 ⁻⁵	1x10 ⁻⁵	1.45x10 ⁻⁴
1kgf/cm ²	9.8x10 ⁴	1	0.98	14.2
1bar	1x10 ⁵	1.02	1	14.5
1psi	6.89x10 ³	7.03x10 ⁻²	6.89x10 ⁻²	1

11 COMMISSIONING

11.1 STEP 1. SINGLE UNIT DEBUGGING

- 1) Check the parameter configuration of the controller;
- 2) Check the gen-set connections and MSC CAN connection lines between the units. (E.g. if 3 generators are correctly connected, SYNC screen will display Module Number: 3).
- 3) In manual mode, check if engine and generator data is normal;
- 4) In manual mode check if switch opens and closes normally;
- 5) In manual mode, after closing the breaker check if generator frequency can be adjusted to the rated frequency (e.g. set the rated frequency as 52Hz/48Hz);
- 6) In manual mode, after closing the breaker check if generator voltage can be adjusted to the rated voltage (e.g. set the rated voltage as 240V/220V);
- 7) Activate manual start on-load, check if power factor, active power and reactive power are normal; if negative value occurs, check generator voltage and current phase sequence, current transformer incoming line direction, current transformer secondary current dotted terminal;
- 8) In manual mode do performance tests according to the national standards.

▲Note: Please refer to HGM9500 Synchronization Plan List for more information on GOV and AVR settings.

11.2 STEP 2: MANUAL PARALLEL OPERATION OFF-LOAD

- 1) Manually close parallel sets, check that the units synchronization is balanced and breaker close impulse current is not too high;
- 2) During parallel operation off load, check that there is no high circumfluence on HGM9510 current screen;
- 3) During parallel operation off load, check if the output of active and reactive power is equal to zero; if it is not, then check if there is power oscillation; if there is, adjust the gain and stability values of HGM9510 controller, or adjust engine GOV or generator AVR gain and stability potentiometer to avoid active and reactive power oscillation; output close to 0.

11.3 STEP 3: MANUAL PARALLEL OPERATION ON-LOAD

- 1) During manual parallel, perform on-load test and check if active and reactive power is evenly distributed between all the gensets;
- 2) During manual parallel, perform ramp on-load test to see if there is high overshoot or power oscillation during this period; if there is, regulate Load Ramp via PC software;
- 3) During manual parallel, perform ramp off-load test to see if gen-set breaker opens after reaching minimum set value (%);
- 4) During manual parallel, perform impact load test and damp load test to check if there is power oscillation.

11.4 STEP 4: AUTOMATIC PARALLEL OPERATION

When the controller is in auto status, if digital input “remote start on-load (on demand)” is active, it will carry out automatic parallel, start and stop operation. There are 3 ways of automatic parallel operation:

- 1) Start on demand: the module with the highest priority starts firstly. When load exceeds the pre-set start maximum percentage, the second according to the priority module will start the gen-set, synchronize and share load. When load falls lower than the preset minimum stop percentage, after stop delay the second module breaker will be open and the module will be cooled down and stopped.
- 2) Start all sets initially: all the modules start at the same time; the first module to reach load condition closes first; when other modules reach load condition, they synchronize one by one. After that the modules monitors the load. If load value falls below module pre-set shutdown minimum percentage, the module with lowest priority enters stop delay and then cools down and stops. If load exceeds the preset start maximum percentage, the generators that are at rest will all start again.
- 3) Balanced engine running time: Engine with the lowest total run time starts first. When the running gen-set total run time exceeds the other gen-set balanced running time, then the gen-set with the next lowest total run time starts (both “start on demand” or “start all sets initially” modes are possible); other gen-sets enter parallel operation after synchronizing. Opening breaker, unloading and stop is performed automatically. All the gen-sets are repeatedly started and stopped according to their total run time.

12 TYPICAL APPLICATION

HGM9510 typical application diagram

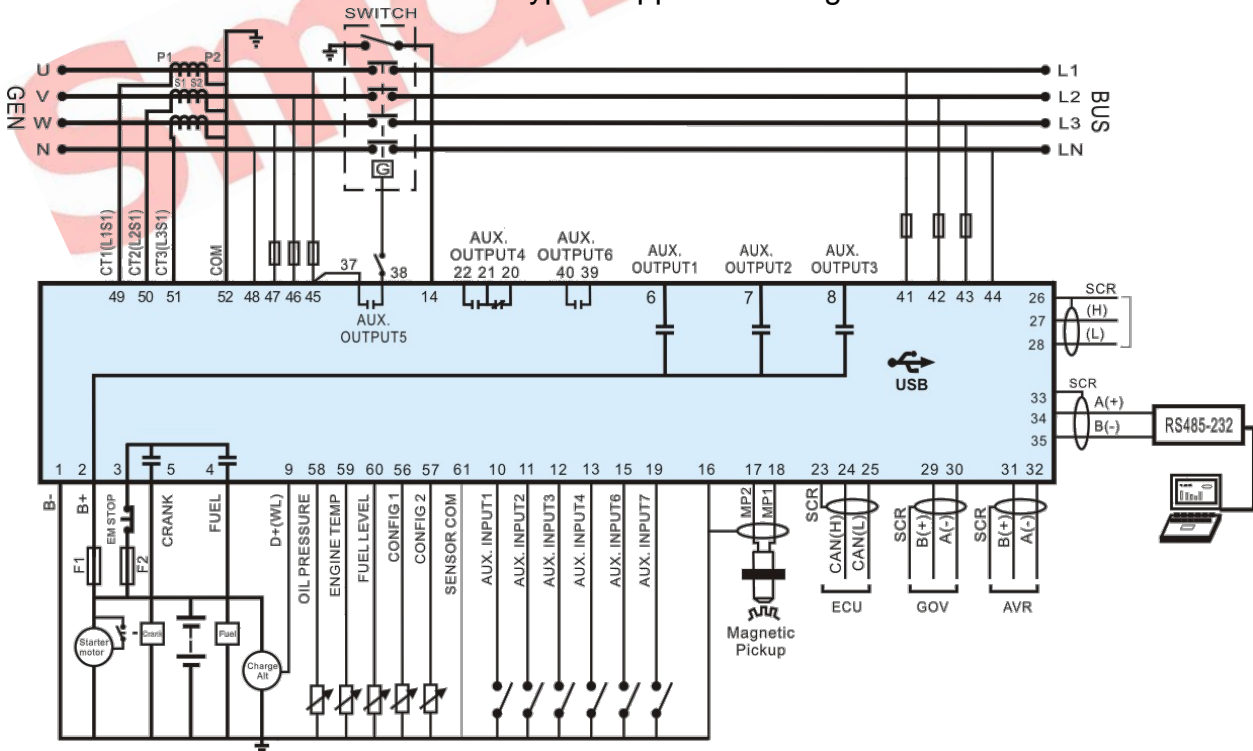

Note: Fuse F1: min. 2A; max. 20A. Fuse F2: max. 32A. Users should select suitable fuse depend on practical application.

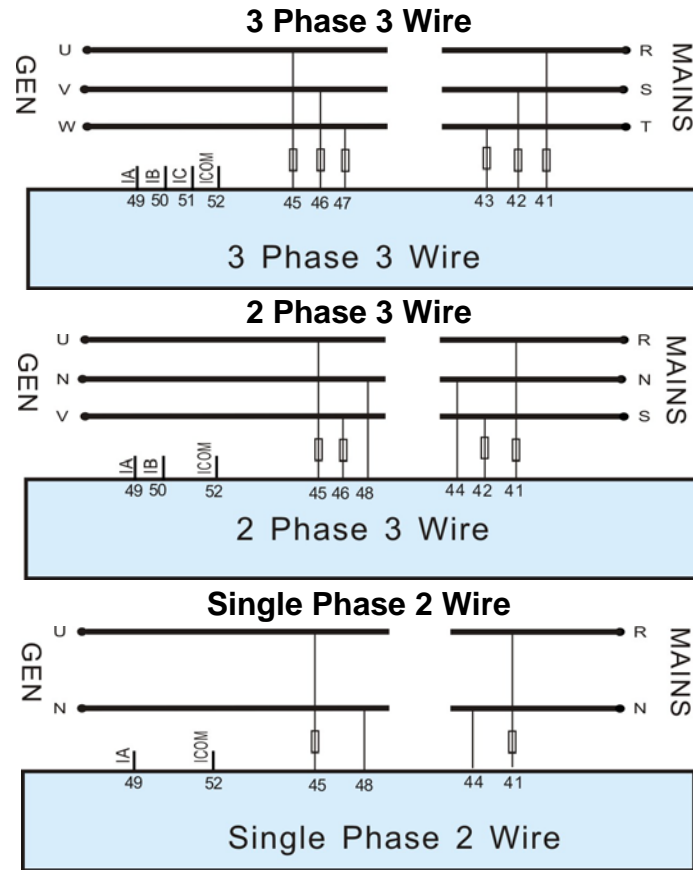

HGM9510 Multi-genset Parallel Application

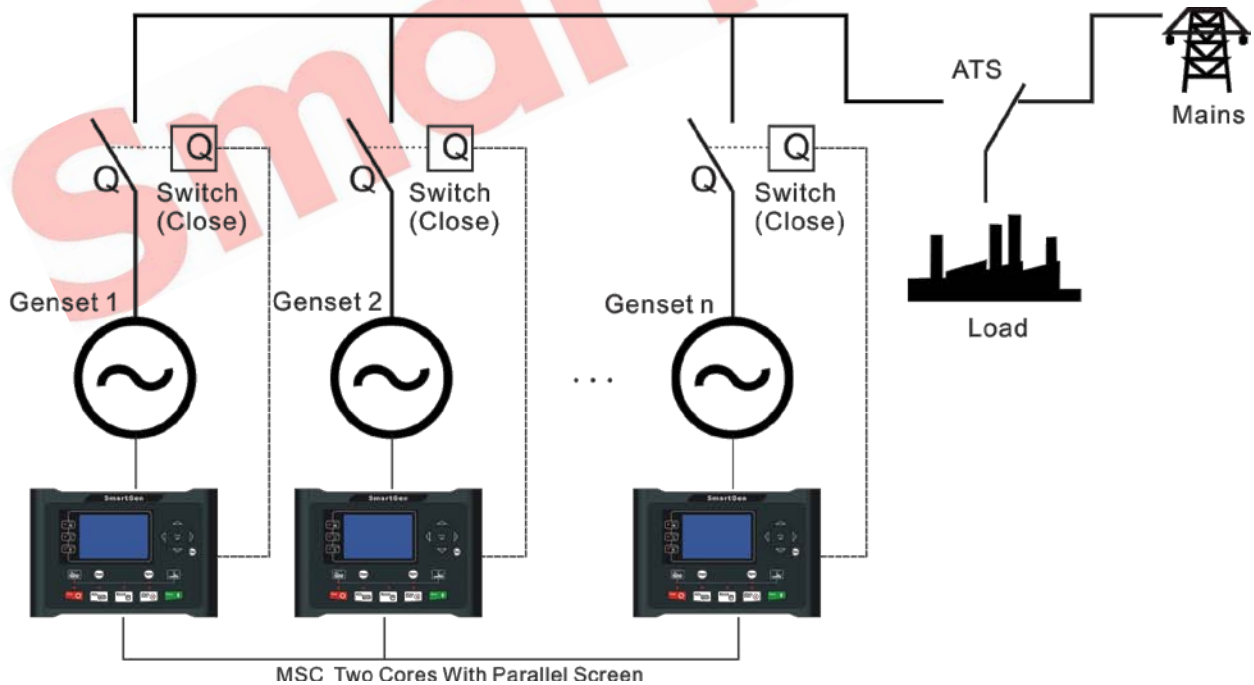

Note: Mains parallel function for HGM9510 controller can be selected via configurable input port. In mains parallel mode, generator will run in parallel with mains and it will only be able to output a fixed amount of power. (Set load mode as Gen control mode).

13 POWER MANAGEMENT MODE

Power management mode can be selected via configurable input ports.

power management mode

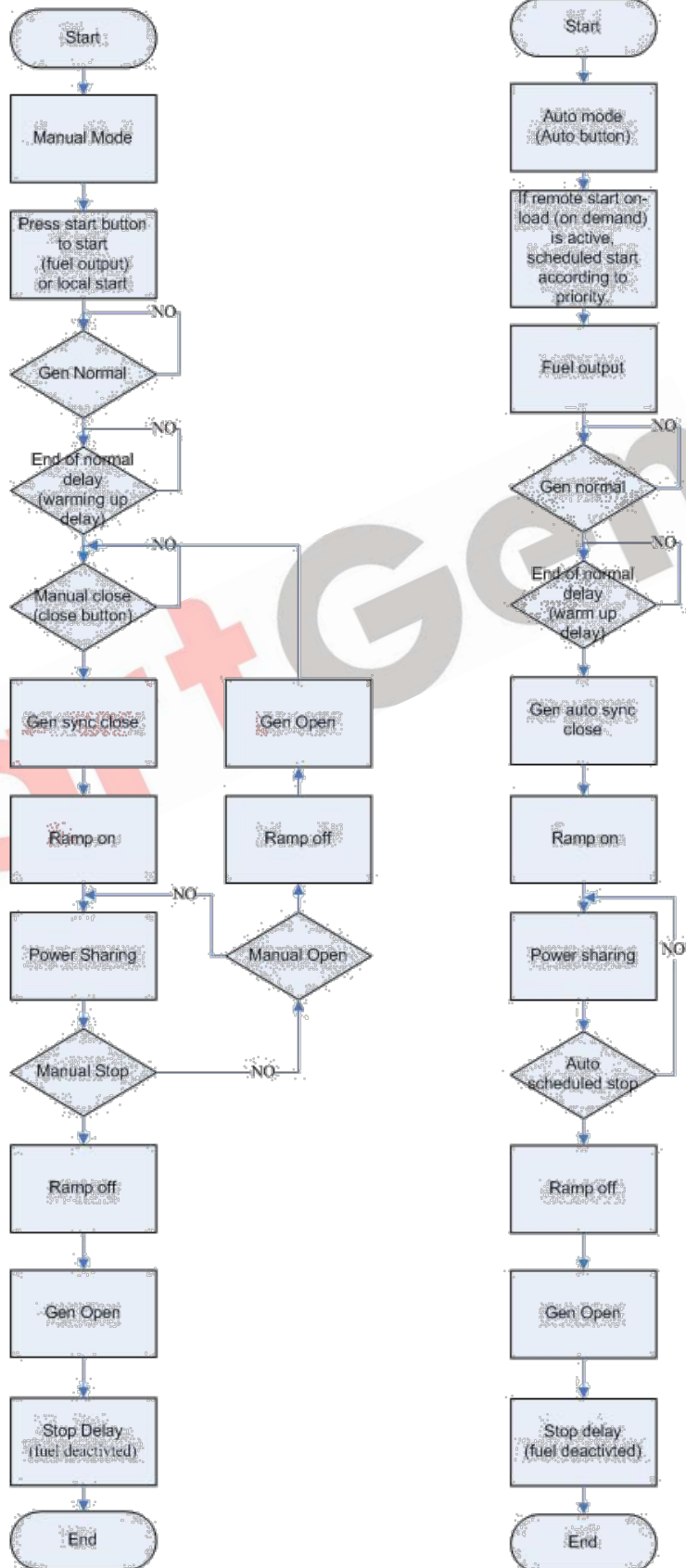
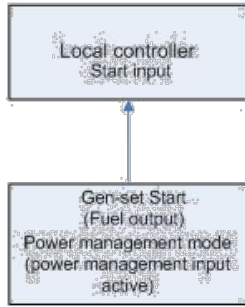

14 LOAD SHEDDING

Non-essential load ---- NEL for short.

The controller can control the NEL1, NEL2 and NEL3 to trip separately. The order of the essentiality is: NEL3 > NEL2 > NEL1

◆ Auto trip:

When NEL auto trip is enabled:

If the genset power has exceeded the NEL trip value, after the trip delay, NEL1 will trip the earliest, and then is NEL2, NEL3;

When NEL auto reconnection is enabled:

If the genset power has fallen below the auto reconnection set value, after the auto reconnection delay, NEL3 will reconnection the earliest, and then is NEL2, NEL1;

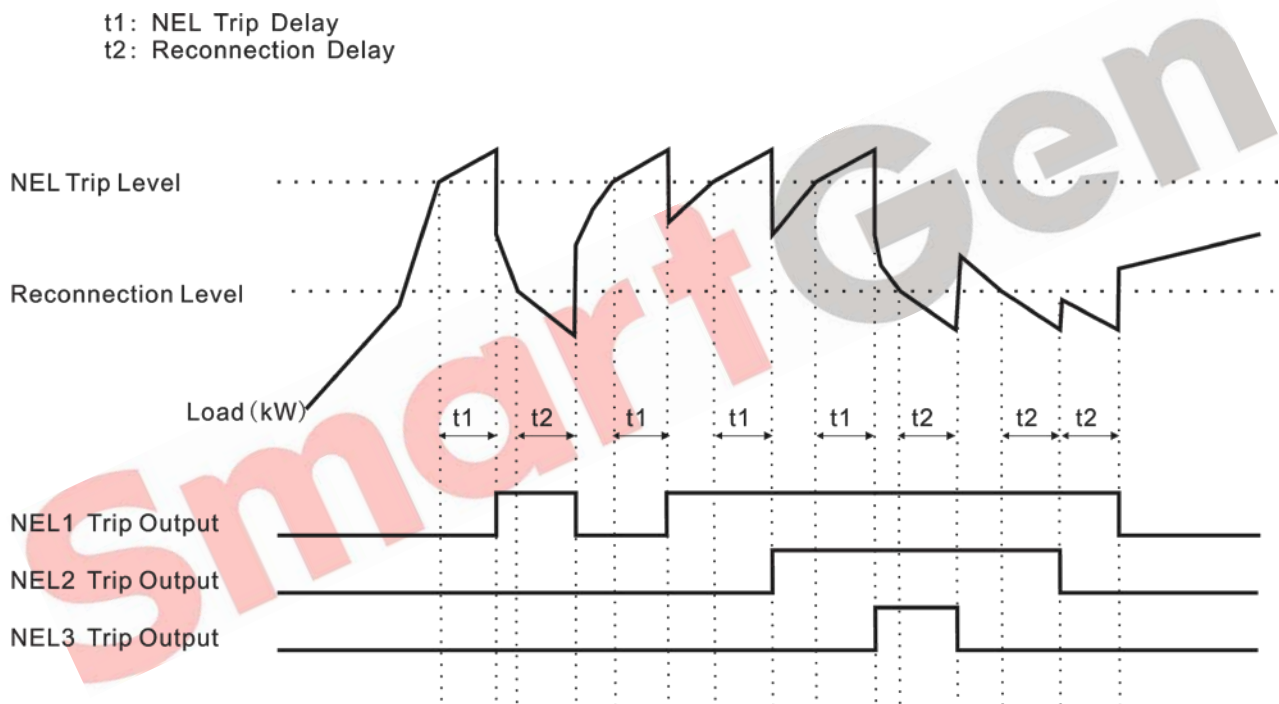

◆ Manual Trip

If NEL manual trip input is active (earthed failing edge is active), NEL1 will trip without delay; If NEL manual trip input is active again, NEL2 will trip; If NEL manual trip input is active the third time, NEL3 will trip. During this process, the controller do not detect if the genset power has exceed the NEL trip value or not.

If NEL manual reconnection input is active (earthed failing edge is active), NEL3 will reconnect without delay; If NEL manual reconnection input is active again, NEL2 will reconnect; If NEL manual reconnection input is active the third time, NEL1 will reconnect. During this process, the controller detects the genset power: if the genset power has fallen below the NEL reconnection value, then the input is active; if it doesn't, the input is deactivated.

▲Note: When auto trip and auto reconnection are enabled, manual trip is still active.

15 INSTALLATION

Controller is panel built-in design; it is fixed by clips when installed. The controller's overall dimensions and cutout dimensions for panel, please refers to as following,

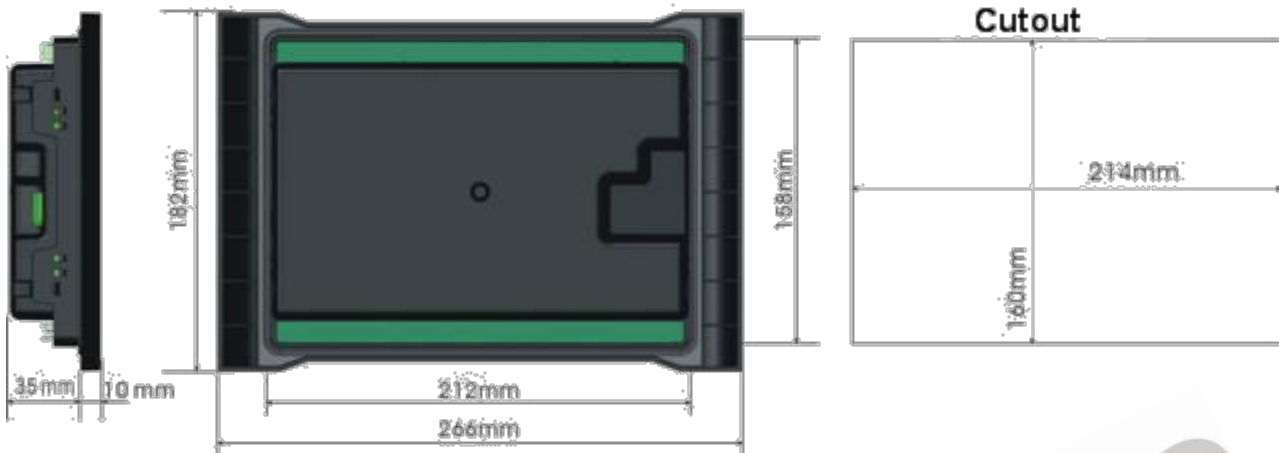

1) Battery Voltage Input

NOTE: HGM9510 controller can suit for widely range of battery voltage (8~35) VDC. Negative of battery must be connected with the shell of starter stable. The wire's diameter must be over 2.5mm² and which is connected to B+ and B- of controller power. If floating charge configured, please firstly connect output wires of charger to battery's positive and negative directly, then, connect wires from battery's positive and negative to controller's positive and negative input ports in order to prevent charge disturbing the controller's normal working.

2) Speed Sensor Input

NOTE: Speed sensor is the magnetic equipment which be installed in starter and for detecting teeth of flywheel. Its connection wires to controller should apply for 2 cores shielding line. The shielding layer should connect to No. 16 terminal in controller while another side is hanging in air. The else two signal wires are connected to No.17 and No.18 terminals in controller. The output voltage of speed sensor should be within AC(1~24)V (effective value) during the full speed. AC12V is recommended (in rated speed). When install the speed sensor, let the sensor is spun to contacting flywheel first, then, port out 1/3 lap, and lock the nuts of sensor at last.

3) Output And Expand Relays

CAUTION: All outputs of controller are relay contact output type. If need to expand the relays, please add freewheel diode to both ends of expand relay's coils (when coils of relay has DC current) or, increase resistance-capacitance return circuit (when coils of relay has AC current), in order to prevent disturbance to controller or others equipment.

4) AC Input

Current input of controller must be connected to outside current transformer. And the current transformer's secondary side current must be 5A. At the same time, the phases of current

transformer and input voltage must correct. Otherwise, the current of collecting and active power maybe not correct.

NOTE: ICOM port must be connected to negative pole of battery.

WARNING! When there is load current, transformer's secondary side prohibit open circuit.

5) Withstand Voltage Test

CAUTION! When controller had been installed in control panel, if need the high voltage test, please disconnect controller's all terminal connections, in order to prevent high voltage into controller and damage it.

16 CONNECTIONS OF CONTROLLER WITH J1939 ENGINE

16.1 CUMMINS ISB/ISBE

Terminals of controller	Connector B	Remark
Fuel relay output	39	
Start relay output	-	Connect with starter coil directly
Auxiliary output port 1	Expand 30A relay, battery voltage of 01,07,12,13 is supplied by relay	ECU power Set configurable output 1 as "ECU power"

Terminals of controller	9 pins connector	Remark
CAN GND	SAE J1939 shield	CAN communication shielding line(connect with ECU terminal only)
CAN(H)	SAE J1939 signal	Impedance 120Ω connecting line is recommended.
CAN(L)	SAE J1939 return	Impedance 120Ω connecting line is recommended.

Engine type: Cummins ISB

16.2 CUMMINS QSL9

Suitable for CM850 engine control module

Terminals of controller	50 pins connector	Remark
Fuel relay output	39	
Start relay output	-	Connect to starter coil directly

Terminals of controller	9 pins connector	Remark
CAN GND	SAE J1939 shield-E	CAN communication shielding line(connect with ECU terminal only)
CAN(H)	SAE J1939 signal-C	Using impedance 120Ω connecting line
CAN(L)	SAE J1939 return-D	Using impedance 120Ω connecting line

Engine type: Cummins-CM850

16.3 CUMMINS QSM11(IMPORT)

It is suitable for CM570 engine control module. Engine type is QSM11 G1, QSM11 G2.

Terminals of controller	C1 connector	Remark
Fuel relay output	5&8	Outside expand relay, when fuel output, making port 5 and port 8 of C1 be connected
Start relay output	-	Connect to starter coil directly

Terminals of controller	3 pins data link connector	Remark
CAN GND	C	CAN communication shielding line(connect with ECU terminal only)
CAN(H)	A	Using impedance 120Ω connecting line
CAN(L)	B	Using impedance 120Ω connecting line

Engine type: Cummins ISB

16.4 CUMMINS QSX15-CM570

It is suitable for CM570 engine control module. Engine type is QSX15.

Terminals of controller	50 pins connector	Remark
Fuel relay output	38	Oil spout switch
Start relay output	-	Connect to starter coil directly

Terminals of controller	9 pins connector	Remark
CAN GND	SAE J1939 shield-E	CAN communication shielding line(connect with ECU terminal only)
CAN(H)	SAE J1939 signal-C	Using impedance 120Ω connecting line
CAN(L)	SAE J1939 return-D	Using impedance 120Ω connecting line

Engine type: Cummins QSX15-CM570

16.5 CUMMINS GCS-MODBUS

It is suitable for GCS engine control module. Use RS485-MODBUS to read information of engine.

Engine types are QSX15, QST30, QSK23/45/60/78 and so on.

Terminals of controller	D-SUB connector 06	Remark
Fuel relay output	5&8	Outside expand relay, when fuel output, making port 05 and 08 of the connector 06 be connected.
Start relay output	-	Connect to starter coil directly

Terminals of controller	D-SUB connector 06	Remark
RS485 GND	20	CAN communication shielding line(connect with ECU terminal only)
RS485+	21	Using impedance 120Ω connecting line
RS485-	18	Using impedance 120Ω connecting line

Engine type: Cummins QSK-MODBUS, Cummins QST-MODBUS, Cummins QSX-MODBUS

16.6 CUMMINS QSM11

Terminals of controller	OEM connector of engine	Remark
Fuel relay output	38	
Start relay output	-	Connect with starter coil directly
CAN GND	-	CAN communication shielding line(connect with controller's this terminal only)
CAN(H)	46	Using impedance 120Ω connecting line
CAN(L)	37	Using impedance 120Ω connecting line

Engine type: common J1939

16.7 CUMMINS QSZ13

Terminals of controller	OEM connector of engine	Remark
Fuel relay output	45	
Start relay output	-	Connect to starter coil directly
Programmable output 1	16&41	Setting to idle speed control, normally open output. Making 16 connect to 41 during high-speed running of controller via external expansion relay.
Programmable output 2	19&41	Setting to pulse raise speed control, normally open output. Making 19 connect with 41 for 0.1s during high-speed warming of controller via external expansion relay.
CAN GND	-	CAN communication shielding line(connect with controller's this terminal only)
CAN(H)	1	Using impedance 120Ω connecting line
CAN(L)	21	Using impedance 120Ω connecting line

Engine type: Common J1939

16.8 DETROIT DIESEL DDEC III / IV

Terminals of controller	CAN port of engine	Remark
Fuel relay output	Expand 30A relay, battery voltage of ECU is supplied by relay	
Start relay output	-	Connect to starter coil directly
CAN GND	-	CAN communication shielding line(connect with controller's terminal only)
CAN(H)	CAN(H)	Using impedance 120Ω connecting line
CAN(L)	CAN(L)	Using impedance 120Ω connecting line

Engine type: Common J1939

16.9 DEUTZ EMR2

Terminals of controller	F connector	Remark
Fuel relay output	Expand 30A relay, battery voltage of 14 is supplied by relay. Fuse is 16A	
Start relay output	-	Connect to starter coil directly
-	1	Connect to battery negative pole
CAN GND	-	CAN communication shielding line(connect with controller's terminal only)
CAN(H)	12	Impedance 120Ω connecting line is recommended.
CAN(L)	13	Impedance 120Ω connecting line is recommended.

Engine type: VolvoEDC4

16.10 JOHN DEERE

Terminals of controller	21 pins connector	Remark
Fuel relay output	G,J	
Start relay output	D	
CAN GND	-	CAN communication shielding line(connect with controller's terminal only)
CAN(H)	V	Using impedance 120Ω connecting line
CAN(L)	U	Using impedance 120Ω connecting line

Engine type: John Deere

16.11 MTU MDEC

Suitable for MTU engines, 2000 series, 4000series

Terminals of controller	X1 connector	Remark
Fuel relay output	BE1	
Start relay output	BE9	
CAN GND	E	CAN communication shielding line(connect with one terminal only)
CAN(H)	G	Using impedance 120Ω connecting line
CAN(L)	F	Using impedance 120Ω connecting line

Engine type: MTU-MDEC-303

16.12 MTU ADEC(SMART MODULE)

It is suitable for MTU engine with ADEC (ECU8) and SMART module.

Terminals of controller	ADEC (X1port)	Remark
Fuel relay output	X1 10	X1 Terminal 9 Connected to negative of battery
Start relay output	X1 34	X1 Terminal 33 Connected to negative of battery

Terminals of controller	SMART (X4 port)	Remark
CAN GND	X4 3	CAN communication shielding line(connect to controller's this terminal only)
CAN(H)	X4 1	Using impedance 120Ω connecting line
CAN(L)	X4 2	Using impedance 120Ω connecting line

Engine type: MTU-ADEC

16.13 MTU ADEC(SAM MODULE)

It is suitable for MTU engine with ADEC (ECU7) and SAM module.

Terminals of controller	ADEC (X1port)	Remark
Fuel relay output	X1 43	X1 Terminal 28 Connected to negative of battery
Start relay output	X1 37	X1 Terminal 22 Connected to negative of battery

Terminals of controller	SAM (X23 port)	Remark
CAN GND	X23 3	CAN communication shielding line(connect with controller's this terminal only)
CAN(H)	X23 2	Using impedance 120Ω connecting line
CAN(L)	X23 1	Using impedance 120Ω connecting line

Engine type: Common J1939

16.14 PERKINS

It is suitable for ADEM3/ ADEM4 engine control module. Engine type is 2306, 2506, 1106, and 2806.

Terminals of controller	Connector	Remark
Fuel relay output	1,10,15,33,34	
Start relay output	-	Connect to starter coil directly
CAN GND	-	CAN communication shielding line(connect with controller's terminal only)
CAN(H)	31	Using impedance 120Ω connecting line
CAN(L)	32	Using impedance 120Ω connecting line

Engine type: Perkins

16.15 SCANIA

It is suitable for S6 engine control module. Engine type is DC9, DC12, and DC16.

Terminals of controller	B1 connector	Remark
Fuel relay output	3	
Start relay output	-	Connect to starter coil directly
CAN GND	-	CAN communication shielding line(connect with controller's terminal only)
CAN(H)	9	Using impedance 120Ω connecting line
CAN(L)	10	Using impedance 120Ω connecting line

Engine type: Scania

16.16 VOLVO EDC3

Suitable engine control mode is TAD1240, TAD1241, and TAD1242.

Terminals of controller	"Stand alone" connector	Remark
Fuel relay output	H	
Start relay output	E	
programmable output 1	P	ECU power Configurable output 1, "ECU power"

Terminals of controller	"Data bus" connector	Remark
CAN GND	-	CAN communication shielding line(connect with controller's terminal only)
CAN(H)	1	Using impedance 120Ω connecting line
CAN(L)	2	Using impedance 120Ω connecting line

Engine type: Volvo

▲NOTE: When this engine type is selected, preheating time should be set to at least 3 seconds.

16.17 VOLVO EDC4

Suitable engine types are TD520, TAD520 (optional), TD720, TAD720 (optional), TAD721, TAD722, and TAD732.

Terminals of controller	Connector	Remark
Fuel relay output	Expanded 30A relay, and relay offers battery voltage for terminal14. Fuse is 16A	
Start relay output	-	Connect to starter coil directly
	1	Connected to negative of battery
CAN GND	-	CAN communication shielding line(connect with controller's terminal only)
CAN(H)	12	Using impedance 120Ω connecting line
CAN(L)	13	Using impedance 120Ω connecting line

Engine type: VolvoEDC4

16.18 VOLVO-EMS2

Volvo Engine types are TAD734, TAD940, TAD941, TAD1640, TAD1641, and TAD1642.

Terminals of controller	Engine's CAN port	Remark
programmable output 1	6	ECU stop Configurable output 1 "ECU stop"
Programmable output 2	5	ECU power Configurable output 2 "ECU power"
	3	Negative power
	4	Positive power
CAN GND	-	CAN communication shielding line(connect with controller's terminal only)
CAN(H)	1(Hi)	Using impedance 120Ω connecting line
CAN(L)	2(Lo)	Using impedance 120Ω connecting line

Engine type: Volvo-EMS2

▲NOTE: When this engine type is selected, preheating time should be set to at least 3 seconds.

16.19 YUCHAI

It is suitable for BOSCH common rail pump engine.

Terminals of controller	Engine 42 pins port	Remark
Fuel relay output	1.40	Connect to engine ignition lock
Start relay output	-	Connect to starter coil directly
CAN GND	-	CAN communication shielding line(connect with controller's this terminal only)
CAN(H)	1.35	Using impedance 120Ω connecting line
CAN(L)	1.34	Using impedance 120Ω connecting line

Battery	Engine 2 pins	Remark
Battery negative	1	Wire diameter 2.5mm ²
Battery positive	2	Wire diameter 2.5mm ²

Engine type: BOSCH

16.20 WEICHAJ

It is suitable for Weichai BOSCH common rail pump engine.

Terminals of controller	Engine port	Remark
Fuel relay output	1.40	Connect to engine ignition lock
Start relay output	1.61	
CAN GND	-	CAN communication shielding line(connect to the controller at this end only)
CAN(H)	1.35	Using impedance 120Ω connecting line
CAN(L)	1.34	Using impedance 120Ω connecting line

Engine type: GTSC1

▲NOTE: If there is any question of connection between controller and ECU communication, please feel free to contact Smartgen's service.

17 USB

Users can set the controller's parameters and monitor the controller's status via the test software which provided by Smatgen company. The connection way between PC and controller as following:



18 FAULT FINDING

Symptoms	Possible Solutions
Controller no response with power.	Check starting batteries; Check controller connection wirings; Check DC fuse.
Genset shutdown	Check the water/cylinder temperature is too high or not; Check the genset AC voltage; Check DC fuse.
Controller emergency stop	Check emergence stop button is correct or not; Check whether the starting battery positive be connected with the emergency stop input; Check whether the circuit is open.
Low oil pressure alarm after crank disconnect	Check the oil pressure sensor and its connections.
High water temperature alarm after crank disconnect	Check the temperature sensor and its connections.
Shutdown Alarm in running	Check related switch and its connections according to the information on LCD; Check programmable inputs.
Crank not disconnect	Check fuel oil circuit and its connections; Check starting batteries; Check speed sensor and its connections; Refer to engine manual.
Starter no response	Check starter connections; Check starting batteries.
Genset running while ATS not transfer	Check ATS; Check the connections between ATS and controllers.
RS485 communication is abnormal	Check connections; Check setting of COM port is correct or not; Check RS485's connections of A and B is reverse connect or not; Check RS485 transfer model whether damage or not; Check communication port of PC whether damage.
ECU communication failed	Check connections of CAN high and low polarity; Check if correctly connected of 120Ω resister; Check if type of engine correct; Check if connections from controller to engine and setting of outputs correct.
ECU warning or stop	Get information from LCD of alarm page; If there is detailed alarm, check engine according to description. If not, please refer to engine manual according to SPN alarm code.